

- ◆ Thank you for purchasing our HD Combine Tester. Please read this user manual before using the HD Combine Tester, and operate it correctly.
- ◆ In order to use this tester safely, please first carefully read "Safety information" in the user manual.
- ◆ Please keep this user manual properly after reading, so that it can be consulted and referred to at any time.
- ◆ Please do not damage the attached warranty certificate or the warranty label posted on the fuselage.
- ◆ Please contact our company's Technology Department if there are some damages or you have some questions/problems while using.
- ◆ If the software version described in the user manual is different from that of the real product, it may appear that both operation screen and operation mode described in the user manual will be not consistent with those of the real product.
- ◆ If both illustrations and interfaces described in the user manual are different from the functional model of the real product, it may appear that the pictures described in the user manual will be not consistent with those of the real product.
- ◆ "*" indicates that only part of models have this function.

Table of Contents

I. Safety Information	01	3.16 Using POE to power the device.....	61
II. Tester Introduction	02	3.17 Using 12V/2A output to power the camera.....	62
2.1 General description.....	02	Specifications	63
2.2 Product highlights.....	02		
2.3 Product functions.....	03		
2.4 Name and functions of various parts/positions.....	05		
III. Operation Instructions	09		
3.1 Battery installation and charging	09		
3.2 Lanyard wearing	10		
3.3 Basic starting	10		
3.4 IP camera test.....	11		
3.5 Analog camrea test.....	25		
3.6 Network tools.....	30		
3.7 Wireless test.....	34		
3.8 Cable TDR test.....	39		
3.9 Record playback.....	41		
3.10 RS485 data monitor.....	41		
3.11 Signal generator.....	42		
3.12 Optical powermeter *	44		
3.13 Digital multimeter *	47		
3.14 System setting.....	58		
3.15 Audio test.....	61		

I. Safety Information

- ◆ When using this tester, please comply with the related local rules of electrical use, and avoid operating it in hospital, gas station, and other places where the electrical use is not allowed.
- ◆ When using this tester, please use the supplied original accessories, so as not to cause any damage to the product due to the use of unauthorized accessories.
- ◆ The accessories supplied for this tester are only for use of its own device. Please do not use them for other purposes, so as to avoid any unforeseen accidents.
- ◆ Please don't let the product get wet or damp, so as to avoid any performance deterioration or damage of the product.
- ◆ Do not allow the instrument be exposed to or contact with any dust or liquid.
- ◆ During transportation and use, do not collide and shake the device violently, so as to avoid any damage to its components, which may make the product not work properly.
- ◆ Please do not leave it unattended when charging the device. If the battery becomes seriously hot, the power shall be cut off immediately. Its charging time should not be more than 8 hours.
- ◆ Do not use it in the areas with high humidity. If the device becomes damp, the power supply and other connecting cables shall be disconnected immediately.
- ◆ Do not use it in the environments containing flammable gases.
- ◆ Please do not disassemble the tester on your own. There are no parts inside the device that can be repaired/ maintained by the user. If you need to disassemble it, please contact our company's technicians.
- ◆ Do not use it in the environments with strong electromagnetic interference.

II. Tester Introduction

2.1 General description

This tester is a test tool designed for on-the-spot installation and maintenance of video surveillance. It combines multiple test functions, which can play a role in installation, maintenance and other work of analog SD, analog HD and network HD video surveillance systems.

This tester is powerful, simple, convenient to operate and easy to carry, which is an essential tool for engineering providers to improve the work efficiency and reduce the engineering costs.

2.2 Product highlights

- ◇ Support analog SD, analog HD and network HD video surveillance systems in one device.
- ◇ Step-by-step test, which can locate the faults quickly.
- ◇ External foldable dual antenna, and dual band Dipole omnidirectional antenna.
- ◇ Highly compatible with ONVIF protocol.
- ◇ Ergonomic, portable design, and single-handed operation.
- ◇ Real-time on-screen operation prompts.
- ◇ POE power supply / receiving, and 12V/2A power output.
- ◇ Dual 1000M network interface, which can detect packet loss, data traffic and so on.
- ◇ 7.0" TFT, 1920*RGB*1200 (resolution), 16.7M (color).
- ◇ Support WiFi test, Spectrum test, and Signal strength test @ 2.4G, 5G Band.
- ◇ Replaceable polymer lithium battery, which can works for 10 hours.
- ◇ Soft rubber protective layer.
- ◇ Dual LED lighting (flashlight).

2.3 Product functions

2.3.1 POE power supply, POE power receiving, 12V/2A output

This function can provide a POE (maximum power: 25.5W) or temporary power supply (12V/2A) for cameras and other devices.

2.3.2 ONVIF test

This function is to carry out a guided IP camera test.

Step 1: Testing the related items of Ethernet connection, and the functions of IP address acquisition or distribution.

Step 2: Discovering the camera, and showing the corresponding video snapshot while selecting the camera.

Step 3: Display the real-time image of the camera, and carry out PTZ control.

After these three steps, the user can continue to set the camera parameters, carry out video snapshot and recording, local zoom display, and other operations.

2.3.3 Analog video test and coaxial PTZ control

It supports to decode and playback analog SD and analog HD signals/images, as well as display image format, resolution and other information.

In addition, it supports coaxial PTZ protocol, which can carry out PTZ control through the coaxial interface while displaying the image.

2.3.4 WIFI / RF tools

This function supports Spectrum testing, WiFi test, Signal monitoring @ 2.4G, 5G frequency band, which can effectively detect whether WIFI signal is interfered in the current environment, and whether the channel data is conflicted / blocked. Signal strength detection can help engineers find the most suitable location and direction for WIFI connection by quickly detecting the signal intensity response.

2.3.5 RS485 PTZ control

This function supports RS485 PTZ control. This tester supports more than 30 kinds of PTZ protocols, which can carry out RS485 PTZ control through RS485 interface.

2.3.6 Image generator

This function mainly generates video signals, which will be used to test analog transmission lines, video recorders and so on. At the same time, the input video signal is displayed on the screen, so as to be convenient for comparing it with the image generated by this device. It supports the formats of video signal such as PAL and NTSC, HD-CVI, HD-TVI, AHD, and HDMI.

2.3.7 Cable TDR

This function uses TDR (Time-Domain Reflection) method to test / measure the length / connection state for the connected RJ45 cable, which can not only measure conductivity, whether there are any phenomena of open-circuit / short-circuit, but also directly display the length of measured cable (accurate to 1 meter). There is no need to connect any auxiliary devices at another end of cable during the measurement process.

2.3.8 Video snapshot, recording and playback

This function allows video snapshot and recording under the conditions of video playback during ONVIF test, and analog video test (including analog SD and HD). Under the condition of record playback, it can playback the snapshot and video which were saved before.

2.3.9 Data monitoring

This function supports to receive some data via RS485 and display on screen. In the case of data received, the user can analyze the received data and obtain the data needed.

2.3.10 Audio test

This function can test microphone and other audio devices at the front-end of video surveillance.

2.3.11 Digital multimeter

This function is a combination of various electrical measuring instruments, which can measure AC / DC voltage, AC / DC current, resistor, capacitor, diode voltage forward drop, circuit conductivity and so on. It has not only the analog pointer with high-precision digital reading and quick response, but also data chart and waveform display. The data recording function can record the measurement results for a long time, so as to be convenient for the later analysis of the engineers. Moreover, this multimeter is equipped with a headset or extension interface, which can connect a headset or be used to connect a variety of measuring extension accessories.

2.3.12 Optical power meter

This function supports to measure the power of laser transmitted through optical fiber with six calibrated wavelength of 850, 1300, 1310, 1490, 1550, 1625nm. In addition, it has the functions of calibration, data recording and saving, which are convenient and quick for the engineers to record the measurement results.

2.4 Name and functions of various parts/positions

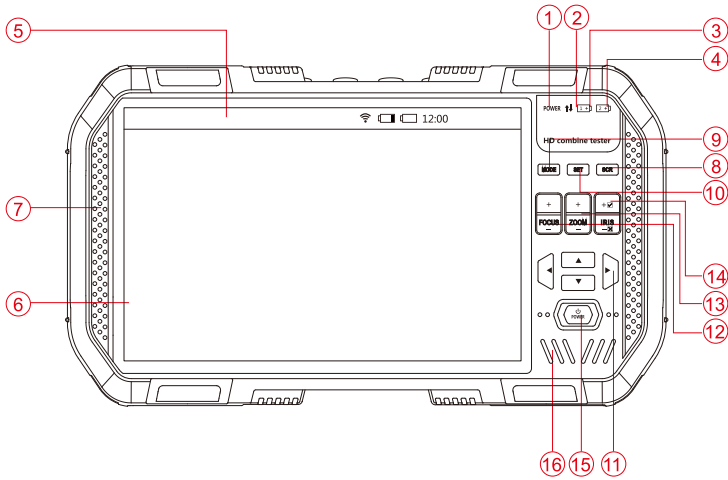

Lower side

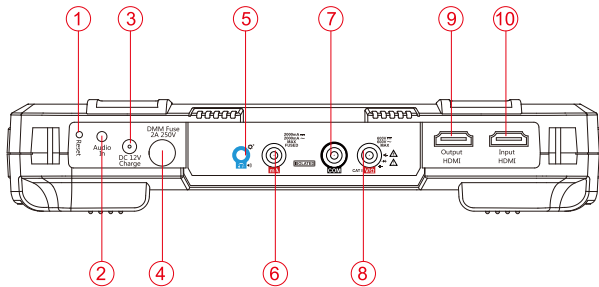

①	POWER	Power indicator light: It is ON when the tester starts up.
②	↕	Data sending / receiving indicator light: When RS485/COAXION sending / receiving the data, it flashes (red).
③		Battery 1 (left) light: It is ON (red) when charging. The indicator light will be automatically OFF When the battery is fully charged.
④		Battery 2 (right) light: It is ON (red) when charging. The indicator light will be automatically OFF When the battery is fully charged.
⑤	Title bar	Display current mode of function, current time and battery level.
⑥	Display area	Display various functional screens and video images.
⑦	Soft rubber protective layer	Improve the feeling of hand, which can play a protective role at the time of collision and fall. It is not replaceable.
⑧		Switch ON/OFF full screen display of video image.
⑨		"Function menu" key: Return to main menu. Use arrow keys for function selection.
⑩		"Setting" button: Enter the parameter settings of the device under each mode of function.
⑪		Arrow keys: Control the PTZ rotation in some functional modules.
⑫		Control the focus during PTZ control.
⑬		Control the zoom during PTZ control.
⑭		Control the iris during PTZ control.
⑮		Power switch: Press and hold it for 2 seconds to turn ON/OFF the tester. When the device is ON/OFF, click this key for two times quickly, which can turn ON/OFF the top LED lighting(flashlight).
⑯		Internal speaker

Back side

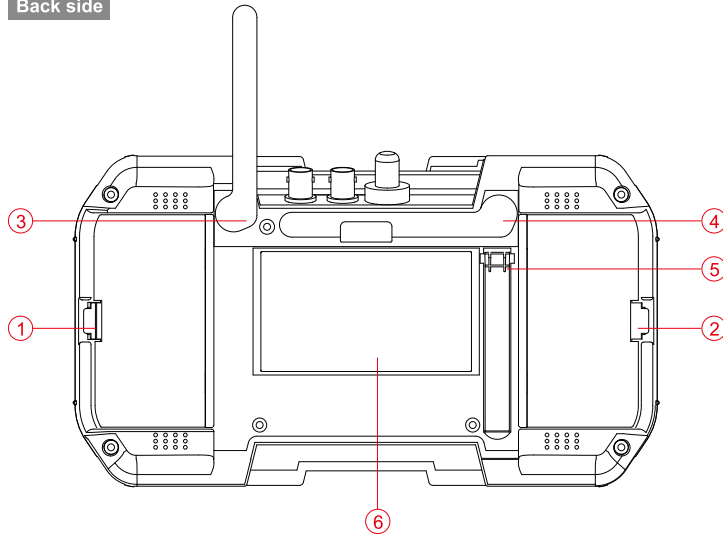

TOP side

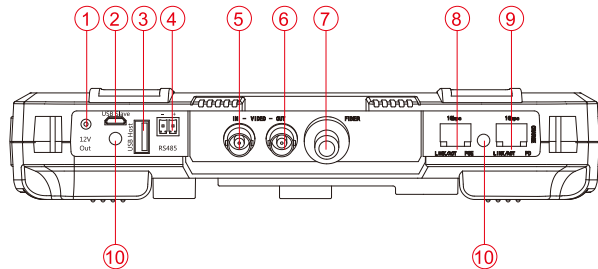

Lower side		
①	RESET	"Reset" button: If necessary, use ball-point pen or other appropriate small tools to press down the keys inside the small hole to restart the tester.
②	AUDIO	Audio input port: 3.5MM Audio input port.
③	DC12 CHARGE	12V/2A charging interface
④	DMM FUSE	Multimeter fuse: It can be replaced after having been fused.
⑤		Digital multimeter, Headset and extension interface
⑥		Digital multimeter, Measuring current (AC / DC)
⑦		Digital multimeter, Common interface
⑧		Digital multimeter, Measure voltage (AC / DC), resistance, capacitance, diode, and circuit ON/OFF.
⑨	OUT PUT HDMI	Output HDMI test signal
⑩	IN PUT HDMI	Input HDMI test signal

Back side			
①	Right (NO.2) battery cover buckle	④	Foldable spectrum antenna
②	Left (NO.1) battery cover buckle	⑤	Device stand
③	Foldable WIFI antenna	⑥	Circuit heatsink

Top side	
①	12V/2A output jack. Outer diameter: 4mm, Inner needle: 1.65mm.
②	MICRO USB jack. It is used to connect with the computer host.
③	USB HOST extension interface
④	RS485 control output. It is used for PTZ control.
⑤	Analog video input BNC connector
⑥	Analog video output BNC connector
⑦	Fiber connector for optical power meter
⑧	Network port 1 (blue), with POE power supply output function.
⑨	Network port 2 (green), with POE power supply input detection function, which is also the device charging input port.
⑩	LED lighting (flashlight)

III. Operation Instructions

3.1 Battery installation and charging

This tester uses rechargeable polymer lithium battery. In order to ensure transportation safety, the battery must be disconnected from the device during transportation.

There are two ways to store the batteries when leaving the factory.

A. Batteries were placed into the battery chamber of the tester, and use a thin plastic sheet to separate their contacts.

In this case, the user shall open the battery cover on the back of the device and then take out the batteries. After that, remove the plastic sheet, then install the battery back, and place the battery cover in position.

B. Batteries were placed outside the tester.

In this case, the user shall open the battery cover on the back of the device, then install the battery, and place the back cover in position.

When the battery is installed correctly for the first time, the tester will automatically turn ON.

If the battery level is too low, the charging indicator light will flash three times and then stop; at this time, the device will not turn ON.

- ◇ When charging the internal battery, please use the matching 12V charger.
- ◇ The tester uses polymer lithium battery, which has no memory effect, so it can be charged at any time according to users' needs.
- ◇ When charging, Red light is ON.  The indicator light will be automatically OFF When the battery is fully charged.
- ◇ POE power supply or POE switch that meets the standards of 802.3af/802.3at can also be used as the power supply for the tester.

 Due to statistical error or other reasons, the battery can only reach 90% when the charging indicator light is OFF. The user can properly prolong the charging time by 30~60 minutes, so as to ensure that the battery is fully charged.

 Do not use non-standard POE power supply to charge the tester, otherwise it may cause some damage to the tester.



3.2 Lanyard wearing

The users can choose whether to wear the lanyard according to their own needs, which can facilitate better handling/control of the tester in operation, so as to effectively prevent the tester from falling when working at high place, and avoid damaging the tester or causing any other losses.

To wear the lanyard, pass its one end through the metal column at corner of the device; meanwhile, pay attention to the direction of diurnal buckle. After that, pass the lanyard through the diurnal buckle once again, and then confirm that the lanyard has been fastened / locked.

3.3 Basic starting

3.3.1 Turning ON/OFF the device

- ◆ When the tester is OFF, press and hold the key of "Power switch"  for over 2 seconds, the front Green power indicator light  will be ON, which indicates the power is ON.
- ◆ When the tester is turned ON, press and hold the key of power switch  for over 2 seconds, the power supply will be OFF. In addition, timed out auto shutdown can also be set.

3.3.2 Using the top LED lighting (flashlight)

When the tester is turned ON/OFF, you can quickly press down the key of "Power switch"  for two times to switch ON/OFF the top LED lighting (flashlight).



The top LED is a LED with high brightness. When switching ON the LED lighting (flashlight), do not look at it directly, so as not to cause any visual injury or any other accidents.

3.4 IP camera test

Please use ONVIF test function to test IP camera. ONVIF test is designed to be a three - step guided operation, which combines the functions of Ethernet test, IP setting, camera discovering, user authentication, image viewing, PTZ control, modification of camera parameter and so on.

Click to select "ONVIF test", and then enter Step 1 of ONVIF test.

3.4.1 : Step 1 —— Power and network connection test

A. Interface content



On the interface, Blue bar represents the status of Network port 1, and Green bar represents the status of Network port 2.

Gray bar shows the information of WIFI network. On the right side, there is a function operation bar.

For the status of Network port:

①  : Indication of Ethernet connection rate, which represents the current status of Ethernet connection.

When the text is displayed as "Link down", it means there is no network connection.

When it is displayed 10M / 100M / 1000M represents the rate of connection used respectively. "FD" means the status of Full duplex; "HD" means the status of Half duplex.

Meanwhile, the state of connection rate can be observed intuitively through the icon.

②  : Statistical display of Ethernet traffic

←represents the amount of outgoing data at this network port, which is in bps/kb/Mb.

→represents the amount of incoming data at this network port, which is in bps/kb/Mb.

③  : Display of Ethernet data packet loss

This icon shows the data packet loss at the corresponding network port. The displayed value is the success rate, which is 100% under normal circumstances.

The color of the icon is different at different success rates, so that it can prompt the user to pay attention to this content. The details are as follows:

RATE	No Link	100%	≥99%	≥95%	<95%
Color	gray	green	yellow	orange	red

④  : Display of POE power supply output state

This icon is for Network port 1, which displays the output state of POE power supply.

The first line represents the output state:

12V: Enable 12V output, meanwhile detect POE device.

PD.CLASS: Carry out the classification measurement on POE device.

PSE 48V: Supply the power to external POE device.

The second line represents the output power, which is in W. When supplying the power to external devices, its actual power is determined by these external devices. The tester has a maximum power limit. When the required power of the device exceeds the maximum power limit, the output will be automatically cut off.

⑤  : Display of POE power receiving state

This icon is for Network port 2, which displays both state and voltage of POE power receiving.

The text content is the input voltage of POE receiving.

⑥ WIFI connection status (gray bar)

Gray bar shows the connection status of WIFI network, including SSID, frequency band, connection rate and so on.

⑦ LAN information

Display the status information of LAN network port, including IP acquisition mode, address of the current IP and mask.

⑧ WIFI information

Display the status information of WIFI network port, including IP acquisition mode, address of the current IP and mask.

⑨ DHCP information

Display the status information of DHCP service for this device, including gateway of this device, address of DNS server, and how many devices acquire the address through DHCP service.

B. Operation methods

1. Connecting to network or camera. It is divided into the following cases:

① Connect to ordinary switch and 12V camera.

Use a standard RJ45 cable to connect to Network port 1 or Network port 2. At this time, the corresponding status information will be displayed on the screen. The network port of the tester supports automatic adapt with of MDI/MDIX connection.

The camera can be powered by the power adapter that the camera comes with, or by the tester. When using the tester to provide 12V output, please use the accompanied 12V output cable to connect 12V output port on the right side of the tester and the power input connector of the camera.

The tester supports a maximum output of 12V/2A. When the required current of the camera exceeds the maximum limit, the output will interrupt automatically.

⚠ Attention: If Network port 1 is connected to POE receiving device, then 12V power supply is disabled, giving priority to POE power supply.

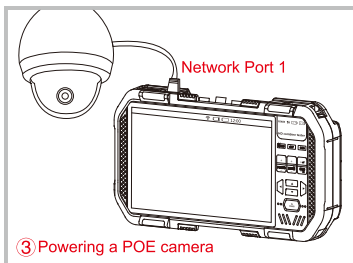
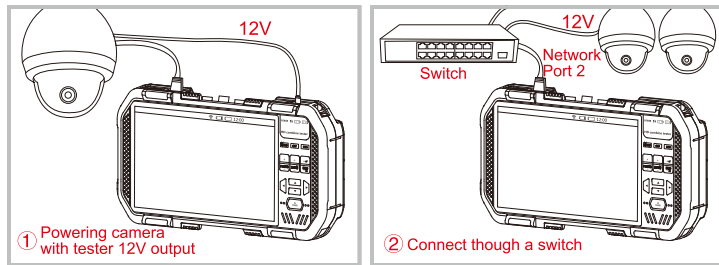

② Connecting to POE switch and charging the tester at the same time.

Use RJ45 cable to connect POE switch and the tester's Network port 2 (green). The orange indicator light of the tester's Network port 2 is ON, which indicates there is an incoming POE. If the battery level of the tester is less than 95%, the charging indicator light will be ON.

One switch can be connected to multiple ONVIF cameras, which may be powered by itself or POE.

③ Connecting to POE camera.

Use RJ45 cable to connect POE camera and the tester's Network port 1 (blue). The tester will first detect whether there is a POE device, and then power it.

When supplying the power to POE device, the tester's 12V output will be disabled.

When the power required by the POE device is greater than the maximum output power of the tester, the output will automatically interrupt.

⚠ This tester's PSE power supply mode conforms to the standards of 822.3at / 802.3at, with the maximum power of 25.5W.



1. LAN IP mode

① LAN DHCP acquisition

This mode is for connecting to a video surveillance network at work.

When the tester enters the ONVIF state, it is DHCP acquisition mode by default.

In this mode, the tester will discover the DHCP service in the network, and attempt to acquire an IP.

After having acquired it successfully, the screen will display the acquired IP.

② LAN static IP

This mode is for connecting a network or camera with static IP.

Click "LAN static IP" on the screen, and then enter the IP setting interface.

Please enter relevant settings.



2. WIFI IP mode

① WIFI DHCP acquisition

This mode is for connecting to a video surveillance network at work through WIFI.

When the tester enters the ONVIF state, it is DHCP acquisition mode by default.

In this mode, the tester will discover the DHCP service in the network, and attempt to acquire an IP.

After having acquired it successfully, the screen will display the acquired IP.

② WIFI static IP

This mode is for connecting a network or camera with static IP through WIFI.

Click "WIFI static IP" on the screen, and then enter the IP setting interface.

Please enter relevant settings.

3. Providing DHCP service

This mode is for connecting a single camera using DHCP.

On the screen, click "Providing DHCP service", and then switch to "DHCP service" mode.

In this mode, the tester will set this device to a static IP, and then enable the DHCP service to distribute IPs for other DHCP devices in the network.

! Attention: If connecting the network in use, where there is a DHCP service in the network, it will cause part of devices to acquire incompatible IP addresses due to multiple DHCP services, which may interfere with the network operation.

4. Using this device as a WIFI hotspot

This mode can set this device as a WIFI hotspot, so as to facilitate other wireless devices to connect to this device for testing.

Click "Using this device as a WIFI hotspot" on the screen, and then enter the function settings (as shown in the figure)

"SSID": Set a name for this hotspot, which can be entered just by clicking the input box.

"Password": Set a password for this hotspot, which can be entered just by clicking the input box. If the authentication method is as "OPEN", the password is set to blank.

"Authentication method": Set an authentication method for this hotspot, which supports three modes : "OPEN", "WPA-PSK" and "WAP2-PSK".

"Channel": Set a working channel for this hotspot.

"Frequency band": Mode of frequency band for the hotspot, which supports two modes of "2.4G" and "5G".

"DHCP service": Whether the hotspot to enable the mode of DHCP service.

5. Connecting to WIFI

Click the button of "Connecting to WIFI" on the screen, and then enter the interface of WIFI connection, as shown in the figure.



Select the name of wireless network that needs to be connected to, and then enter the password. At this time, the designated WIFI network will be connected to just by clicking "Connecting to WIFI".

6. WIFI and LAN bridging

Through this function, both LAN network and WIFI network of this device can be bridged, so as to connect the devices in these two networks.

Click the button of "WIFI and LAN bridging" on the screen. If the device has been properly connected to LAN network / WIFI network, then the connection icon on the main page will light up, as shown in the figure.



7. Entering the next test step

After it is confirmed that the tester's network connection information is normal, and the tester has acquired its IP, press the Next step key to enter the next test.

3.4.2 : Step 2 —— Discovering the device

This step will discover and list the cameras in the network, meanwhile it will display the snapshots of the cameras for quick identification.

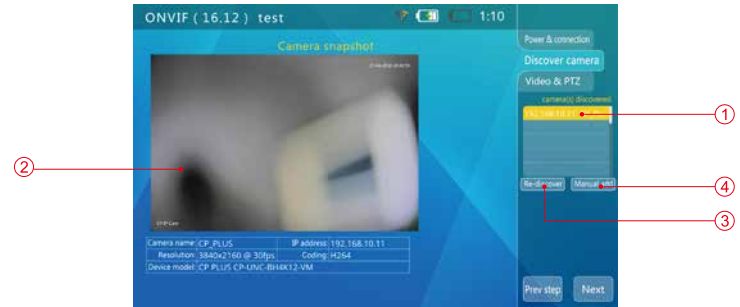

1. Camera list: It displays the camera that has been discovered, which can be selected by clicking on it.
2. Camera state and snapshot: When camera is selected, the status bar will display the snapshots and information of the camera directly. If need ONVIF authentication, the status bar will display "Camera needs to be authorized". Can the snapshots and information of the camera be displayed normally only after entering the correct user name and password.
3. Re-discovering: Clear the camera list and restart the operation of rediscovering.
4. Manually adding: Remote cameras can be added for further operation by manually adding their domain names or IP addresses.

3.4.2.1 Camera list

This step will discover and list the cameras in the network, meanwhile it will display the snapshots of the cameras for quick identification.

After entering this step, the software automatically broadcast the ONVIF discovery data, and attempt to discover the cameras in the network, then add them to the list on the right side.

The number of discovered cameras will be displayed on the top of the list.

When the camera doesn't appear on the "Camera list", click the button of "Re-discovering" to clear the list, and then restart the operation of rediscovering.



Attention: When part of cameras cannot respond/appear on the "Camera list" due to they are located in different network segments, the user shall first return to Step 1, and then modify the IP of this device, so as to make it be in the same network segment of the camera (Please note that the IP can't conflict with other devices in the network after modification.); after that, enter Step 2, and attempt to discover the camera.

3.4.2.2 Viewing the snapshot and camera image parameters

In the "Camera list", click and select the camera; 1~3 seconds later, the video snapshots of the selected cameras will appear on the left side of the screen for the user to quickly identify.

The resolution, refresh rate and compression mode of camera video are displayed below the image.

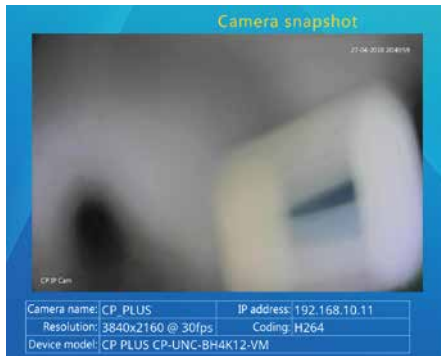

Some cameras need ONVIF authentication, That is, it prompts that the camera needs to be authorized on the position of information display (as shown below). Can the camera information be displayed only after carrying out the operation of user login. For its operation methods, see "Use of authentication and password".



3.4.2.3 Use of authentication and account book

Some cameras need ONVIF authentication. That is, it prompts that the camera needs to be authorized on the position of information display. At this time, click the user name and password, and then enter the corresponding information through virtual Keyboard on the screen; after that, click the key of "Login" for authentication.

If need to use the function of account book, click the button of  on the screen, and then enter the interface of account book (as shown in the figure).

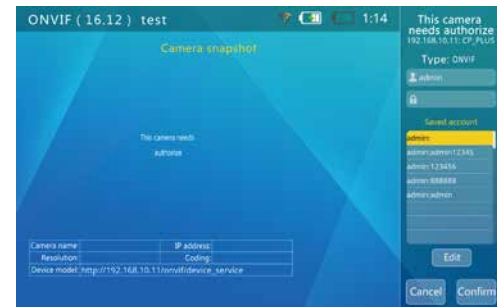

Select the preset account and password, then click the button of "Confirm" to log in.

If need to add, delete or modify the preset account and password, click the button of "Modify" to enter the modification interface (as shown below).



After having set the information content that needs to be added, then just click the button of "Save".

3.4.2.4 Manually adding a camera

Click the button of "Manually adding a camera", and then manually add a camera (as shown in the figure)



To manually add a camera, the user needs to know both IP address and ONVIF service path of the camera.

After having entered the designated address by clicking the middle input box on the screen (you can quickly select the frequently-used text of address format on the right selection box for shortcut input), press the button of "Confirm", and then log in.

3.4.3 : Step 3 —— Video and PTZ

This step can display the real-time video of the camera, control PTZ rotation, and set the camera parameters.

3.4.3.1 Displaying the real-time image of the camera

Enter Step 3, and automatically display the camera image.

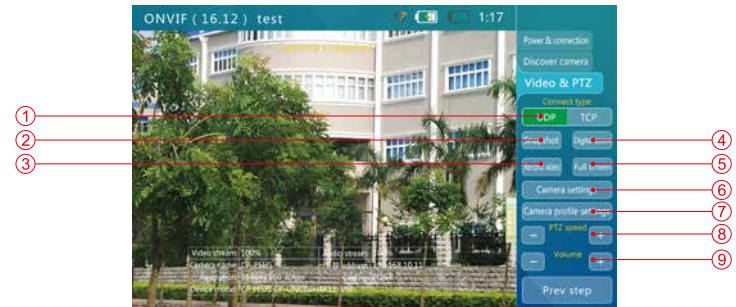

1. Click it to switch between UDP and TCP.
2. "Snapshot": Click it to snap shot the current camera screen.
3. "Recording": Click it to record the camera video.
4. "Full screen": Click it to display the camera image in full screen.
5. "Digital zoom": Click it to enter the interface of "Digital zoom" (as shown in the figure) Click the button of "+/-" to zoom the image for display; meanwhile, move the camera image by the green block directly.
6. Camera setting
Click the button of "Camera setting" to enter the camera parameter setting interface. (as shown in the figure)



Its left side displays the setting classification, and its right side displays the specific setting content.

The setting classification is as follows:

Name	Description
Network interface	The settings of camera network interface include IP, gateway and so on. For the camera with multiple network interfaces, there may be multiple network interface settings.
Service	Gateway, DNS server and other information. The gateway or DNS server can be modified here.
System	Camera restarting, restoring the factory settings, whether the device can be discovered, HTTP port information and etc.
User	Display the user name and level. The user information can be deleted here.
Device information	Model, manufacturer and other information of the camera. These contents of the classification cannot be modified.

⑦ Camera Profile setting

Click the button of "Camera Profile setting" to enter the interface of Profile setting (as shown in the figure), and then set the image parameters such as camera resolution, quality, data rate, and frame number.

⑧ "PTZ speed"

Click the button of "PTZ speed", and then adjust the PTZ movement speed, where it supports Level 1-10 adjustment.

⑨ "Volume"

Click the button of "Volume", and then adjust the camera volume, where it support Level 1-10 adjustment..



3.4.3.2 ONVIF PTZ control

Press the button of "Full-screen display", and then switch to the status of full screen video. At this time, the interface disappears, and the video image will occupy most of the screen.

Due to the difference of aspect ratio, part of the screen will be black, where no content is displayed.

In the state of full screen, you can use  and  to control the camera PTZ.

3.5 Analog camera test

This function can be used to test the analog video signals, and display the images, image formats, etc., as well as send PTZ control commands, test and control PTZ.

3.5.1 Connecting to analog camera

For analog camera, its video is connected by using a BNC connector. Use a BNC connecting line to connect the video of analog camera to VIDEO IN connector at the top of the tester.

The camera can be powered by its own power supply or 12V/2A output provided by the tester.

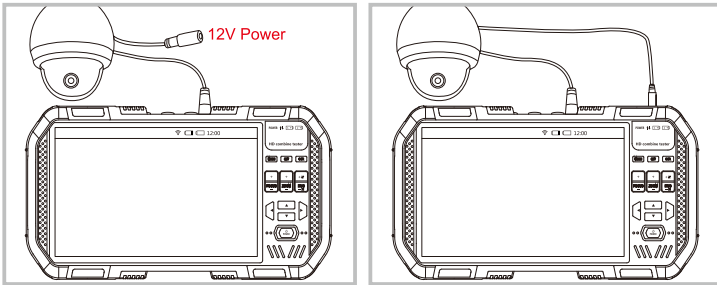

Attention:
 The maximum output power of the tester is 12V/2A. When the power exceeds the maximum power, the output will cut off automatically. If connecting a camera with high-power IR lighting, it is necessary to pay attention to this limit.
 While Network port 1 is connected to a POE device, 12V output will be disabled.

3.5.2 Analog camera test

Click / select the button of "Analog camera test" to enter the interface of analog video test.



1. Coaxial HD decoder

The system currently supports three formats of coaxial HD decoder: CVI, TVI and AHD. The default state of the system is to automatically identify the input signal format; meanwhile, the input signals can be decoded by a manually designated decoder.

2. PTZ setting

Click "PTZ setting" to enter the settings of RS485 / coaxion PTZ control (as shown in the figure).



Adjust the relevant contents /parameters according to the prompts.

Various settings are described as follows:

RS485 PTZ control

Protocol	Set the protocol used by the camera PTZ. The tester supports a variety of PTZ protocols.
Baud rate	Baud rate used by RS485 communication.
PTZ address	Address code of the controlled PTZ. Due to different understanding of each manufacturers, the address may deviate from +/-1, whose setting range will be determined according to various PTZ protocol.
Preset position	The current PTZ state can be saved in the PTZ controller of the camera. This function needs some support from PTZ controller (for details, please refer to Camera manual).
Call	PTZ can be quickly restored to the PTZ state saved before. This function needs some support from PTZ controller (for details, please refer to Camera manual).

After setting, press the key of "Return" to exit. Then, various settings are immediately effective.

Connect the matching RS485 wires to the controlled PTZ's RS485 communication line, and then just use , ,  and  to control PTZ rotation

Coaxial HD PTZ control

The signals of coaxial HD PTZ control are directly communicated with the camera through video lines. Various settings are described as follows:

Protocol	Set the protocol used by the coaxial PTZ. CVI protocol (dahua coax), AHD protocol (Pelco c) and TVI protocol (Hikvision)
Baud rate	No use of baud rate in coaxial control
PTZ address	No need to set any address for coaxial control
Movement speed	Expected PTZ speed, with the setting range of 10%~100%.
Preset position	The current PTZ state can be saved in the PTZ controller of the camera. This function needs some support from the corresponding controller (for details, please refer to Camera manual).
Call	PTZ can be quickly restored to the PTZ state saved before. This function needs some support from the corresponding controller (for details, please refer to Camera manual).

Call some certain special preset position No., which can call the OSD menu function of dome camera (for details, please refer to Camera manual).

3. Analog video snapshot / Analog video recording

In the interface of analog video, click the button of "Snapshot" to snapshot the current video. At this time, it will display "The snapshot is saved", file name and path.

In the interface of analog video, click the button of "Record video" to start recording the current video; press the button of "Record video" once again to end the recording. At the end of the video recording, it will display "The recording is saved", file name and path.



4. OSD menu

Call the OSD menu function of dome camera (for details, please refer to Camera manual).

Click on "OSD menu" button on screen or press "IRIS+" button (depend on camera) will turn on camera OSD menu. Use  arrow keys and "IRIS+" key to operate the menu. For protocol selection and OSD function detail, please refer to camera manual.



5. Digital zoom

In the interface of analog video, click the button of “Digital zoom” to enter the state of Digital zoom. (as shown in the figure)



Press the button of “-” / “+”, and then zoom out / in the image. At this time, Digitally zoomed image is displayed.

Move the display area by dragging the green box on the screen, so as to view the different parts/positions of the image.

6. Full-screen display

In the interface of analog video, click the button of “Full-screen display” to enter the mode of full-screen display (as shown in the figure).

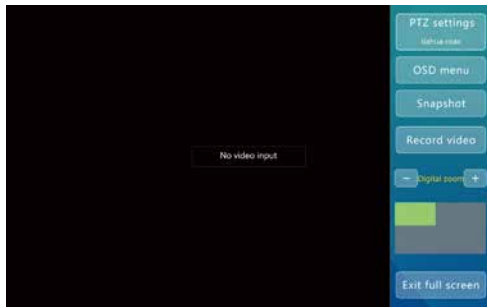

After 2 seconds without any operation, the right menu bar is automatically hidden, and then the camera image will be displayed in full screen.

Click on the screen, and then re-call out the right operation menu to carry out the corresponding operation.

3.6 Network tools

Click the button of "Network tools" to enter the interface of network tools (as shown in the figure).



1. IP setting

In the interface of network tools, click the button of "IP setting" to enter the interface of IP setting (as shown in the figure).

If DHCP services are provided in the network, you can select the key of "DHCP" to automatically acquire IP, DNS and gateway address. Otherwise, you need to select “Manual setting”, and then enter IP, DNS, gateway and other contents.

2. Connecting to WIFI

Click the button of “Connecting to WIFI” on the screen, and then enter the interface of WIFI connection, as shown in the figure.

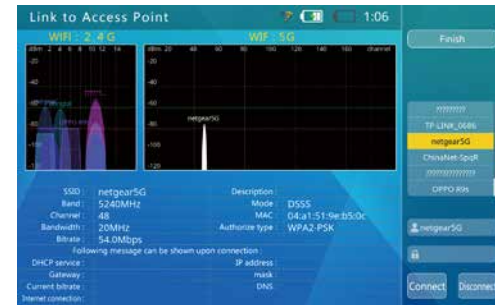

Select the name of wireless network that needs to be connected to, and then enter the password. At this time, the designated WIFI network will be connected to just by clicking “Connecting to WIFI”.

3. PING

Ping is a frequently-used function in network testing. The function of "Ping" can be used to check whether the network is connected or not, and acquire the information such as channel delay, which may well help us to analyze and determine the network faults.

To use the function of Ping test, IP address, mask and target address need to be set. When the target is a name rather than an IP address, it is necessary to set DNS server and gateway. If need to modify IP, mask, DNS and gateway, click the address input box next to "Ping target", and then enter the designated IP address.

After setting, click the button of "Start" to start the Ping test.

The Ping test displays the results in the form of chart. The demonstration display contents are as follows:



Bar chart shows each time delay period and the percentage of packet loss for the Ping target.

Line chart shows the Ping target address delay within the recent 120 seconds. (Y-axis: Logarithmic scale, and X-axis: Ping packet sending-out time.)

The Ping function can save the test report. Click the button of "Save the report", and then generate a report. This report is saved in the built-in memory of the tester (/NetworkTest), which can be viewed by using a USB cable to connect with PC. You can also access the tester through FTP, and then acquire the report. FTP address is IP address of the tester, and its account and password are both "ftp".

The example of the report is as follows:



Attention: This example is only for reference, and cannot be used as a test standard

Exit the PING function by clicking the button of "Stop".

4. Sniff

Click the button of "Sniff" on the screen to enter the interface of sniff, which does not need to set any network parameters and target addresses, which can be started directly just by clicking the button of "Start". (as shown in the figure)

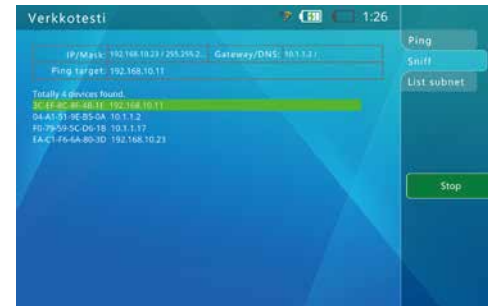

After the sniff detection starts, it will monitor the network continuously, as well as detect both MAC and IP of the received broadcast packets. If any unlisted MAC or IP, they will be automatically added to the list.

The list format is: XX-XX-XX-XX-XX-XX I.I.I.I

XX: MAC address, displayed in hexadecimal. I: IP address, displayed in decimal.

Most network devices send out some broadcast packets periodically, indicating their own existence. By detecting these packets, the function of sniff detection can be used to discover some devices with unknown IP in the network.

When need to connect to a camera with unknown settings and unknown IP, it is necessary to first test the function of DHCP distribution; and if this camera does not actively acquire any IP, it may uses a static IP. At this time, you can use the function of sniff detection to discover the device.

! Attention: The function of sniff detection does not detect any unicast (point-to-point) packets. According to its frequency of data transmission, it usually takes 3~60 seconds to discover the device by means of the function of sniff detection, or the device can't be discovered due to it always keeps silent.

The function of sniff detection only detects the broadcast packets, so it doesn't distinguish the network segments, which can discover not only the devices across the network segment, but also various Ethernet devices that do not have any IP address.

Exit the function of sniff detection by clicking the button of "Stop".

5. List subnet

To use the function of list subnet, both IP and mask of the tester need to be set. The mask must be of 24 bits, that is, the subnet size is of 256.

After setting the IP and mask, click the button of "Start" to start the function of subnet list.

The function of list subnet can be used to scan all devices in the subnet. The designated device must respond, so all the normally- working devices in the same subnet will be 100% scanned out. In addition, this function of subnet list can also be used to measure the speed of the network, which is in milliseconds. (as shown in the figure).



For subnet list, its display format is: XX-XX-XX-XX-XX-XX I.I.I.I N ms
 XX : MAC address, displayed in hexadecimal. I: IP address, displayed in decimal.
 N: Network delay.

! Attention: This function cannot be used to detect the devices across the network segment, but the success rate on the same network segment is 100%. It needs to take 1~10s to finish the subnet list.

Exit the function of subnet list by clicking the button of "Stop".

3.7 Wireless test

This function can be used to scan both spatial signal and WIFI hotspot @ 2.4G/5G WIFI frequency band. It can display the usage of frequency band / channel in the current area, providing a powerful basis for the engineers to adjust and optimize the network.

The device adopts the hardware structure of external foldable dual antenna (dual-band Dipole omnidirectional antenna), which is as shown in the figure:

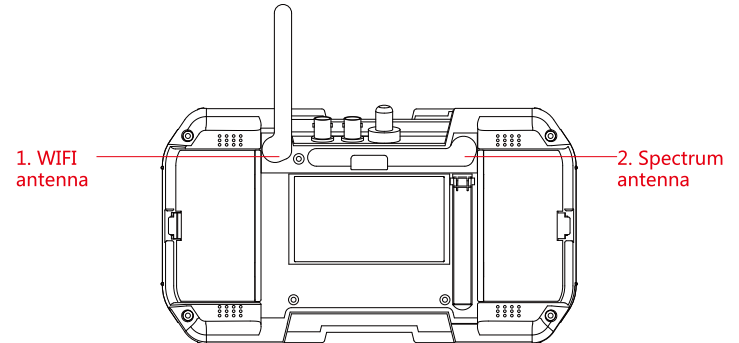

The external antenna is of release design, so as to prevent the antenna from breaking due to collision when opening it. If the antenna falls off due to collision, the user can align its rotating shaft to the original installation position, and then press it back with a little force. Attention: The antenna conductor shall be naturally bent. Never pull, fold, twist it by force or make it get stuck. If the antenna is damaged, please contact the after-sales service personnel for its replacement.

When using the function of wireless test or WIFI connection, please open the corresponding antenna. When not using the wireless function, the antenna shall be retracted, so as to avoid any collision.

Click the button of "WIFI / RF tools" to enter the interface of wireless test.

3.7.1. Spectrum test

This function supports 2.4G, 5G frequency band, which can be used to scan/detect both spatial spectrum signals and WIFI hotspots in the current environment. Among them, the spatial spectrum detection is used to detect and display all the spatial data's communication signals and noise (interference) signals; the WIFI spectrum test is used to display the scanned WIFI hot spots in the form of spectrum graph.

The interface of spectrum test is as shown in the figure:

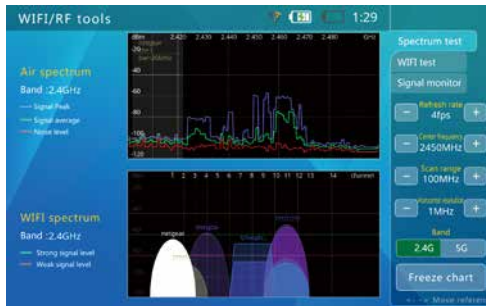

Selection of "frequency band"

Select the air signals and WIFI hotspots @ 2.4G or 5G frequency band for detection and display.

When select "2.4G" or "5G" frequency band by clicking, the interface will display the name of discovered WIFI hotspots @ the current band immediately.

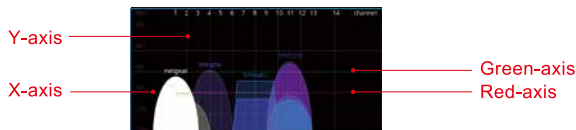

Y-axis (in dBm) represents the level of WIFI hotspot signal

Red line represents the reference line of weak signal level (-80dBm); if lower than this line, WIFI signal is at a weaker level.

Green line represents the reference line of strong signal level (-60dBm); if more than this line, WIFI signal is at a stronger level.

X-axis represents the channel of WIFI signal.

For the function of "WIFI spectrum", the channel No. will be identified according to the standards of 802.11a/b/g/h/j/n/ac/ax.

In the map of WIFI hotspots, Ellipse represents the hotspots of DSSS signal modulation (Fig. 1), and Trapezium represents the hotspots of OFDM signal modulation (Fig. 2). For the map of WIFI hotspot, its height indicates the level of hotspot signal received by this device; its width indicates the bandwidth usage for this hotspot. (the color of hot spots is selected randomly.)

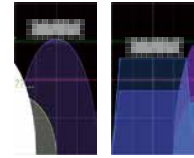

If there are multiple WIFI signals using an overlapping channel in the space, there will be some signal congestion, which may cause a communication delay, therefore this function can be used to discover a more idle channel in the space for use, so as to solve the problems of signal congestion / communication delay.

When need to select a certain hotspot signal for test, you can just click the hotspot directly on the screen. After selection, the hotspot will become white. If some hotspots can't be selected due to overlapped, select the hotspots to be tested by using the button of "Left" and "Right".

After selecting a hotspot, a white column will appear in the interface of "Air spectrum".



Y-axis (in dBm) represents the level of spatial air signals.

X-axis (in GHz) represents the signal frequency.

White column represents the frequency range of the currently-selected hotspot.

Red curve represents the test results of noise level.

Green curve represents the test results of average signal intensity.

Blue curve represents the test results of signal peak.

The function of "Air spectrum" supports the detection within the spectrum range of 2.40 ~ 2.50G and 5.0 to 5.8G, which covers the spectrum signal range (802.11a/b/g/h/l/n/ac/ax standards).

For spatial air spectrum function test, the signals include all the signals with the same frequency, such as WIFI, Bluetooth, ZigBee, non-standard signal, and radio noise.

Through this function, it is observed that Red line at a certain frequency point is at a higher level, which means that there is some strong signal interference at this frequency. If for the selected WIFI hotspot signal, there is some signal interference within the spectrum range of white column, which means that there may be some WIFI communication delay, packet loss and other abnormal problems.

For spatial air spectrum, the measurement results of Green line and Blue line indicate the usage of the corresponding frequency. When Green line is at a higher level, it indicates that the occupancy rate is higher at this frequency, which may cause some WIFI communication delay, packet loss and other abnormal problems.



In order to observe the spatial spectrum conveniently, you can also adjust the working parameters of spectrum test by using the following function buttons.

“Refresh rate” Click the button of “+/-”, and then adjust the spectrum refresh rate. Lower refresh rate is convenient for discovering the statistics of signals; higher refresh rate makes it easier to detect the beating of signals in a timely manner.

“Center frequency” Click the button of “+/-”, and then adjust the spectrum center.

“Scanning range” Click the button of “+/-”, and then adjust the range of scanning/ displaying frequency.

“Horizontal resolution” Click the button of “+/-”, and then adjust the resolution of scanning frequency.

“Freeze chart” Click it, and then keep the image of current spectrum at a standstill, so as to be convenient to observe.

3.7.2 Wifi test

Click the button of “Wifi test” to enter the function (as shown in the figure).



This function can be used display the received WIFI hotspots @ 2.4G and 5G frequency band in the form of spectrum, as well as list all SSID of visible hotspots on the right side. After clicking the selected hotspots in the list, the detailed parameters of this hotspot will be displayed in the middle of the image. This hotspot needs to be logged in before its network information can be displayed. If need to log in a hotspot, click the input box of “”, and then enter a correct password; after that, click it for connection. If the connection is successful, the specific network information of this hotspot can be displayed (as shown in the following figure).

3.7.3 Signal monitoring

Click the button of “Signal monitoring” to enter the function (as shown in the figure).

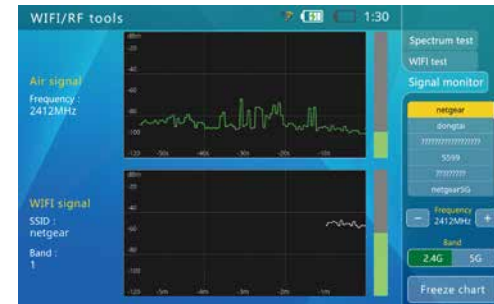

Click / select the hotspot in the right WIFI list, and then the “frequency” below will jump to the central frequency point of this hotspot channel; after that, start detecting the signal intensity at this frequency point. (as shown in the following figure)



Y-axis (in dBm) represents a signal level at the frequency.
X-axis is a time axis.
Green bar quickly display the signal change at the frequency point.

Y-axis (in dBm) represents a signal level of the channel.
X-axis is a time axis.
Green bar quickly display the signal change of the channel.

With the aid of the above two charts, the engineers can test and observe the signal intensity of this WIFI hotspot at different position, angle and direction, which can also display the channel occupancy at the corresponding frequency points, so as to assist engineers to select the proper installation position and direction when installing WIFI devices.

3.8 Cable TDR test

Click “Cable TDR test”, and then enter the interface of TDR test. (as shown in Fig. 1)



Fig. 1

When the icon of “Measuring tape” flashes on the interface, it indicates that the network port is being measured.

The measurement results of network port are as shown in Fig. 2, where 12, 36, 45 and 78 are 4 pairs of twisted-pair in the RJ45 cable respectively. The state includes Normal, Open-circuit and Short-circuit. The length or the position of breakpoint shows the length of measured cable or the length between the breakpoint and the test point. The cable attenuation value is used to measure the cable attenuation, and the quality of measured cable.

When entering this function, one measurement will be done automatically.

If need to measure it once again, click the button corresponding to the color of network port, and then start a new measurement. When need to carry out a continuous measurement, click the button of “Continuous measurement”. When the prompt changes to “Stop continuous test”, it indicates that it is in the state of continuous measurement currently.

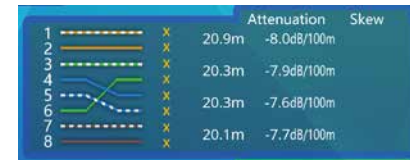
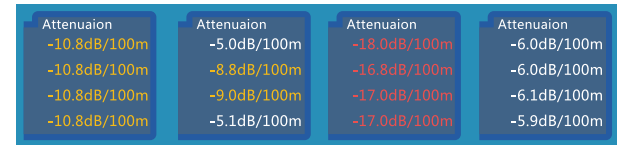

Fig. 2

Example of measurement quality (as shown in Fig. 3):



poor quality cable 36 45 pairing error water poured cable eligible cat5 cable



Attention:

These test results are affected by temperature, humidity, cable diameter, cable medium and other conditions, so the measurement results are for reference only, and cannot be used as official measurement results.

Continuous measurement is convenient for measuring multiple cables, which does not increase the accuracy of measurement.

When the cable is connected to a terminal device for measurement, the echo may very weak due to good termination of cable, or there is some impedance discontinuity caused by a damage or joint in the middle part / position of the cable. In this case, the measurement results may be significantly less than the actual length, so it is recommended to disconnect the terminal devices during the measurement.

3.9 Record playback

The tester can snapshot and record both analog and IP camera videos, and then save them in the built-in memory. This function can be used to list out the snapshots and videos saved before, as well as view these snapshots and playback the video contents.

“Delete”: Delete folders, snapshot images, recording videos and other contents.

“Re-name”: Re-name folders, snapshot images, and recording videos.

“New a directory”: New a folder for saving.

“Set as default directory for today”: When selecting this function, all snapshot images and recording videos will be saved in this folder on that day.

“Full-screen display”: Playback the snapshot images and recording videos in full screen.

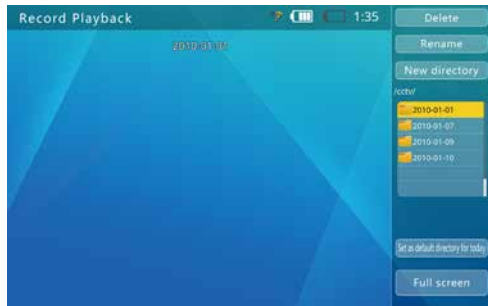

3.10 RS485 data monitor

When maintaining the front-end dome camera, this function can be used to receive and display the data on the RS485 bus. Use these data to analyze whether the protocols of PTZ controller are normal or not.

Connection methods: Use RS485 connecting cable accompanied with the tester to connect RS485 interface of the tester and the tested RS485 communication bus. Red alligator clip: To D+; Black alligator clip: To D-.

Click / select the button of “RS485 data monitor” to enter the interface of analog video test.



Click the button of “+ / -”, below “Baud rate”, and then set the baud rate, so as to make it be in line[match] with that of the measured RS485 bus. When the tester receives some data, these data will be displayed on the screen. Press it match to pause / resume receiving the data.

The tester will carry out an automatic line break according to the received data. Click the button of “+ /-” below “Display line width” to set the line width.

Click the button of “Clear the data”, and then clear the displayed data.

3.11 Signal generator

Click the button of “Signal generator”, and then enter the function of signal generator.

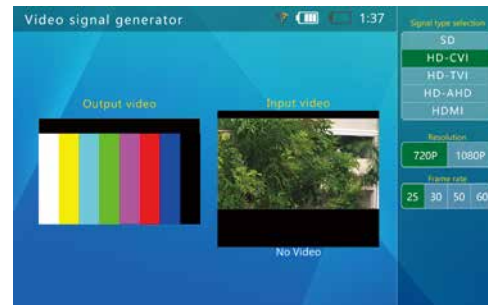

“System select”: Test image format, which supports the format selection of SD (PAL and NTSC), HD-CVI, HD-TVI, AHD, HDMI.

“Resolution”: Switch the resolution of coaxial HD signal test image between 720P / 1080P.

“Refresh rate”: Select the resolution of the output video signal.

Application examples of signal generator

As shown in the figure:

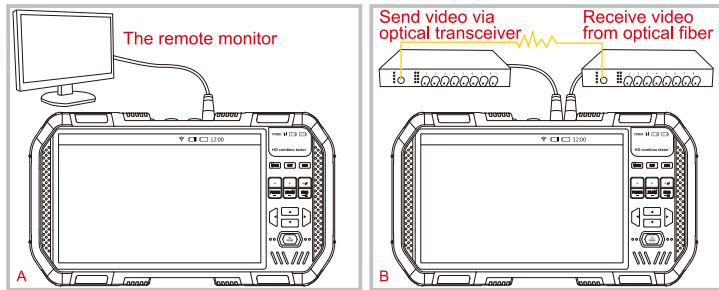

A. Transmit the test video to the remote monitor or video recorder, and then judge the transmission quality (good / bad) of the transmission line by viewing the image quality in the remote monitor.

B. Convert the video signals output from VIDEO OUT port to optical signals through the transmitting end of optical transmitter / receiver, and then convert them back to analog video signals through the receiving end of optical transmitter / receiver, which will be input via VIDEO IN port. The transmission quality (good / bad) of optical transmitter / receiver can be judged by comparing the two images in the interface.

3.12 Optical powermeter *

Click the button of “Optical powermeter” to enter the interface of Optical powermeter (as shown below).



After Connecting the optical fiber to be tested into Fiber IN port of the tester, the tester will display measured laser power value.

1. Wavelength selection

Click “Wavelength”, and then select the test wavelength according to the actual demand; if the test wavelength is not at the calibrated wavelength point, use a nearby calibrated wavelength.

2. dBm / mW selection

Click “dBm” or “mW”, then select / display the power unit as “dBm” or “mW”.

3. Locking the display

When clicking the button of “Hold display”, the displayed contents are locked, and will not change, so as to be convenient for reading. Press the button of “Hold display” once again to cancel the locking.

3.13 Digital multimeter *

HD Combine Tester has the function of digital multimeter, which can be used to measure AC / DC voltage and current, resistance, capacitance, diode and circuit conductivity. In addition, it is equipped with some extension interfaces, which can expand more measurement functions.

Click the button of "Digital multimeter" to enter the function of digital multimeter. The functional interface of digital multimeter is as follows:



- A: Difference and Locking status prompt
- B: Digital readings
- C: Analog pointer
- D: Data recording
- E: Data record chart or waveform of AC signal
- F: AC/DC indication
- G: Function selection
- H: Manual/automatic range

1. Operation methods

a) Click/select the required measurement function. The functions corresponding to the letters or symbols are as follows:

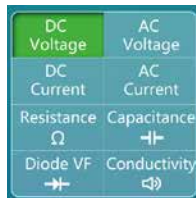

b) According to the selected function, connect the test probe correctly. (as shown in the figure)

i. Voltage (AC/DC), resistance and capacitance measurement. Connect the red probe to V/Ω, and the black probe to COM.

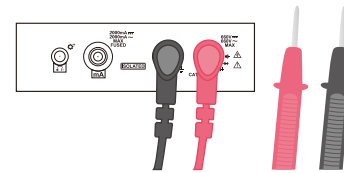

ii. Diode and circuit conductivity measurement Connect the red probe to V/Ω, and the black probe to COM According to the needs, connect a common headset to the headset interface, so as to clearly listen to the prompts in noisy environment.

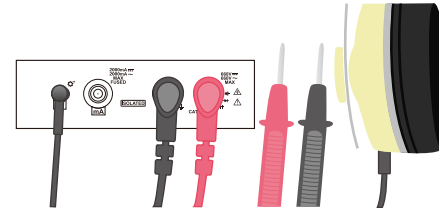

iii. Current (AC/DC) measurement. Connect the red probe to mA, and the black probe to COM.

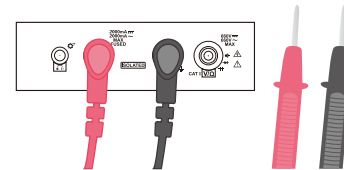

c) After having connected the probes correctly, connect the circuit or component to be tested, and make some readings.

i. Voltage (AC/DC) measurement

Connect the red probe with the circuit to be tested directly.

The rough value or variation trend of the measured voltage can be read out quickly from the analog [Simulated analog]pointer. After the digital reading is stable, a high-accuracy reading can be read out.

When using digital multimeter to measure the voltage, its default range is automatic range. In the process of measurement, if its range is not suitable, the tester will automatically change the range.

For the function of AC voltage measurement, the reading is true RMS. There will be a base readings when the circuit to be tested is not connected, which does not affect the measurement accuracy of large voltage (>200 readings).

In the range of 2V, even if the probes are short circuited, there may be a readings of -10~+10mV on the tester. The influence of this parasitic value can be eliminated by means of difference measurement. (For details, please refer to the section of "Difference measurement".)



Attention:

The maximum voltage of the circuit to be tested is 600V (DC) or 600V (AC).

When the voltage of the circuit to be tested is higher than 36V, pay attention to its insulation, so as to avoid any personnel injury caused by electric shock.

ii. Current (AC / DC) measurement

Connect the probe correctly as shown in b.3.

The power of target circuit is disconnected first. Cut off the points to be tested in the target circuit, and then connect Black probe and Red probe to the circuit in series. After that, connect the power of the circuit to be tested.

The rough value or variation trend of the measured current can be read out quickly from the analog pointer. After the digital readings is stable, a high-accuracy readings can be read out.

When using digital multimeter to measure the current, its default range is automatic range. In the process of measurement, if its range is not suitable, the tester will automatically change the range.

For the function of AC current measurement, the readings is true RMS. There will be a base readings when the circuit to be tested is not connected, which does not affect the measurement accuracy of large current (>200 readings).



Attention:

The current connector of digital multimeter has a one-time fuse. When the current is too large, this fuse will burn out, so as to protect both the measured circuit and the tester. After the fuse burns out, the function of current measurement will not work. At this time, the readings is zero, and the circuit is open. When replacing the fuse, please replace with the same type of fuse.

The maximum allowable input voltage for fuse is 250VAC/400VDC.

The circuit to be tested may be at a high level, so it is necessary to pay attention to this, so as to prevent any personal injury caused by electric shock during the operation.

When the tester switches the current range, its internal resistance will change obviously. This may change the state of the circuit under test, thus lead to different measurement results, which is a normal phenomenon.

When measuring the current, the flowing current will heat up the internal sampling components, which may affect the accuracy of measurement. Therefore, when measuring a large current (>0.1A), the measurement duration shall be controlled within 15 seconds, so as not to reduce the accuracy.

iii. Resistance measurement

The function of resistance measurement can be used to measure the resistance value of resistors or circuits.

After connecting the probes to both ends of the resistor or circuit to be tested, the tester will automatically adjust the range to a suitable range, and then carry out the measurement. The rough value or variation trend of the measured current can be read out quickly from the analog pointer. After the digital readings is stable, a high-accuracy readings can be read out.

When measuring a small resistance, first short the probes, and then enter the mode of "Differential measurement", which can eliminate some of the influence caused by the resistance of lead. (For details, please refer to the section of "Difference measurement".)



Attention:

When measuring a circuit, it is necessary to confirm that the power of the tested circuit is cut off, otherwise no correct result can be measured.

Different measuring currents will be applied in different range of resistance measurement. If the measured components or circuit is not of linear characteristics, it is possible that a large difference in measurement results will be obtained in different ranges, which is a normal phenomenon.

iv. Capacitance measurement

Capacitors shall be discharged before measuring them. Especially for large-capacitance (>100uF) or high-voltage (withstand voltage >50V) capacitors, it shall be confirmed that they have been discharged before the measurement; otherwise, it may cause some electric shock hazard to human body or damages to the tester.

For small capacitors (<100uf), whose current voltage is below 50V, the tester will discharge them automatically before measurement.

Black probe and Red probe of the tester are connected to two pins of the tested capacitor. If the capacitor has polarity, please connect Red probe to its positive terminal (+), and Black probe to its negative terminal (-). The tester will automatically select an appropriate range for measurement. The rough value or variation trend of the measured current can be read out quickly from the analog pointer. After the digital readings is stable, a high-accuracy readings can be read out.

For the capacitor to be tested, if its capacitance is larger (>1000uF), the measurement time may be longer (>1s), which is a normal phenomenon.



Attention:

The capacitor to be tested shall be measured separately instead of being installed in the circuit; otherwise, it will get some wrong measurement results or fail to obtain the readings. When the capacitor to be tested is of electricity leakage, its measured value will be significantly larger. If the leakage of electricity is serious, no readings may be obtained. Before measurement, if the capacitor has a higher voltage (>5V), it may not be measured normally. If the voltage of the capacitor exceeds the maximum allowable value of internal protection circuit, it may damage the tester.

If the capacitor has a higher voltage (>36V), it may cause some personal injury when touching.

v. Diode measurement

The function of diode measurement can be used to not only measure its forward voltage drop of diode, but also help to find its Anode/Cathode.

Connect Red probe to the positive pole (Anode) of the diode, and Black probe to the negative pole (Cathode) of the diode. The tester will display the forward voltage drop of the measured diode.

If the forward voltage drop is displayed as "OL", it indicates that the diode is connected inversely or damaged.

When the diode's forward voltage drop is less than 30mV, the buzzer of the tester will sound, which indicates that the measured diode may have broken down or damaged.

In noisy environment, a headset can be used for measurement.



Attention:

The diode to be tested shall be measured separately, rather than installed in the circuit.

vi. Circuit conductivity measurement

The function of circuit conductivity measurement can be used to judge the circuit conductive or insulated by measuring the resistance of the tested circuit.

Disconnect the power of the measured circuit, and wait until some possible electricity of energy storage capacitance in the circuit is consumed completely.

After connecting Black probe and Red probe with the circuit to be tested, the tester will display its resistance value. When the resistance of the measured circuit is less than 30Ω, the buzzer of the tester will sound, which means that the circuit is connected conductive.



Attention:

Circuit conductivity is a relative concept. For circuit conductive/insulated, the user shall make a substantive judgment according to actual circuit and measurement value, which can NOT be judged only by the buzzer.

When a large capacitor exists in the circuit to be tested, the measurement value may vary continuously due to the capacitor of the measured circuit is being charged, which is a normal phenomenon. In the process of charging, a smaller resistance cannot be considered that the circuit is connected conductive, which shall be judged only after the readings is stable.

The power of the circuit to be tested must be disconnected; otherwise, the correct measurement results cannot be obtained.

d) Automatic / manual range

When the prompt of automatic range is Green, it means that the tester works in the state of automatic range. When measuring voltage, current, resistance and capacitance, enter the mode of manual range by pressing range+/- . At this time, the prompt of automatic range is gray. Click "Range +" or "Range-" to increase or decrease the range.

If want to restore the automatic range, click the button of "Automatic range".

e) Locking the display

When measuring, click the button of “Hold display”, and then lock the readings and analog pointer. The prompt of "Hold display" button is Green.

Click the button of “Hold display” once again, and then unlock the data locking.

! Attention:

Under the locking state, the tester is actually continuing measurement. The function of automatic range and prompting is still working; meanwhile, the function of data recording continues to work. Under the mode of data record chart, the chart continues to be refreshed. Under the mode of waveform display, the waveform is frozen, which is no longer refreshed.

f) Difference measurement



During the measurement, click the button of “Difference measurement” to enter the mode of difference measurement. The prompt of difference measurement turns Green. At the same time, the tester will automatically switch to the manual range. The tester will remember / take the measured value once pressing the button as the reference value, and then the new measurement results will be subtracted from the reference value. After that, the difference will be displayed.

To exit the difference measurement, click the button of “Difference measurement” once again. The prompt of difference measurement turns gray.

When measuring small voltage (range of 2V) or small resistance (range of 2kΩ), the function of difference measurement can be used to reduce the influence of parasitic voltage and lead resistance. Measurement method: First short-connect two probes, and then enter the mode of difference measurement after the readings is stable. After that, measure the circuit or resistor to be tested.

g) Recording the data

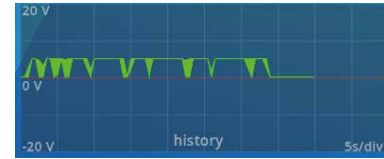

This tester has the function of data recording. Click the button of “Record data” to start recording the data. The data recording duration will be displayed within the box of data recording time.

Press the button of “Record data” once again to stop recording the data.

! Attention: When starting the data recording, the tester will automatically switch to a fixed range. If the readings of measured circuit or component is near the full-scale range, in order to avoid any readings which is beyond the range during the process of recording, please switch to a higher range manually. When the data recording is finished, the state of automatic range will not be resumed.

If need to record the data for a long time, please adjust the tester’s option of “Automatic shutdown” to “Appropriate time”, or close this option.

The data records are saved in the memory of the tester. The file name is the date and time when starting the data recording. For example: /DMMDATA/2016-10-10_12-01-01.txt, where the first line of the file is the settings of measurement, including measuring item, measuring range, unit of readings, starting time, interval time and so on; from the second line, each line is one record, which does not contain its unit.

#	A	B	C	D	E
1	Recorded data of Digital Multimeter.				
2					
3	Start the 2 records per second.				
4					
5	function:DC Voltage				
6					
7	unit:100uV				
8					
9					
10	minimum : maximum reading				
11					
12		-40	-39		
13					
14		-40	-40		
15					
16		-40	-40		
17					
18		-40	-40		
19					
20		-40	-40		
21					
22		-40	-40		
23					
24		-40	-40		
25					
26		-40	-40		
27					
28		-40	-40		

h) Data temporary storage

This tester has the function of data temporary storage. Click the button of "Data temporary storage", and then temporarily store the current data in the data temporary storage sheet (as shown below).

Click the button of "Clearing the temporary storage", and then clear the data records in the data temporary storage sheet.

Temporary memory		
Time	Function	Reading
1:18:53	DIO	OL
1:18:48	CAP	OL
1:18:46	RES	000.00mA
1:18:45	ACA	000.00mA
1:18:44	DCA	-0010.5mV
1:18:42	ACV	-0010.5mV
1:18:41	DCV	-0010.5mV

i) Matters needing attention

i. Some attention must be paid to prevent any electric shock when measuring a high-voltage circuit. Do not touch any metal part of the probe; otherwise, it may cause some personal injury due to electric shock.

ii. The electrical measurement section of the tester is electrically isolated from its other circuits. When measuring, it is safe to touch non-electrical measurement interfaces, such as BNC interface, network port, audio input port, headset interface, charging port, battery port, RS485 interface and USB interface.

iii. Electrical measurement interfaces are the COM, V/Ω and mA interfaces. When measuring high voltage (>36V) circuits, do not touch the metal parts of these interfaces.

iv. When measuring the resistance, capacitance, diode and circuit conductivity, one voltage is connected by error, which may cause some damages to the tester or the circuit to be tested. The tester has the capacity of automatic protection when the voltage connected by error is less than a certain range. However, this protection can be only used for limited times. Frequent protection will reduce the accuracy of the tester. If connecting the voltage beyond the protection capacity, it will cause some permanent damages to the tester.

v. The headset interface can be connected with 3.5mm three-contact headset, which can also be connected with part of four-contact headsets.

vi. In addition, the headset interface is an extended interface, which can be connected with some special extension accessories.

2. Range and accuracy (25±5°C)

Item	Measuring range	Range of readings	Minimum resolution	Accuracy
DC voltage (DCV)	2V, 20V, 200V, 600V	±19999	0.1mV	±0.1%+8*
AC voltage (ACV) (True RMS)	20V, 200V, 600V	±1999	1V	±1.2%+3
DC Current	20mA, 200mA, 2000mA	±19999	1uA	±0.1%+8*
AC Current (True RMS)	20mA, 200mA, 2000mA	±1999	1uA	±1.2%+3
Resistor	2KΩ, 20KΩ, 200KΩ, 2MΩ, 20MΩ	0~19999	0.1Ω	±0.1%+8*
Capacitance	2nF, 20nF, 200nF, 2uF, 20uF, 200uF, 2mF, 20mF	0~1999	1pF	±4%+5
Diode forward voltage drop	2V	0~19999	0.1mV	±0.1%+20
Conductivity	2KΩ	0~19999	0.1Ω	±0.1%+20



Attention:

For the range of DC 2V, DC 20mA, no-load readings shall be deducted.

When measuring a small resistance, pay attention that the resistance of the probe shall be deducted.

Electronic Parameters

Item	Parameters	Description
Measurement features		
Factory calibration temperature	25±5°C	
Temperature stability	<100ppm/°C	Except for large current
User self calibration range	±1%	measurement

Data rate	5 reading/s	DC Voltage, DC Current, resistance, diode and circuit conductivity measurement.
	2 reading/s	AC voltage, AC current measurement
	0.1~5 reading/s	Capacitance measurement
Refresh rate of analog tester	20~40fps	Except for capacitance measurement
X-axis of data record chart	1s/div,5s/div,25s/div	Automatic switching
X-axis under the mode of waveform display	10ms/div	
Waveform refresh rate	1time/s	No synchronization
Frequency range of AC measurement	0Hz~1000Hz	The harmonics above 1KHz will cause some error.
Current for diode measurement	1mA±5%	
Breakdown prompt threshold	30mV	
Current for circuit conductivity measurement	1mA±5%	
Prompt threshold for circuit conductivity measurement	30Ω	
Response time for circuit conductivity measurement	<2mS	
Internal resistance of current measurement	Range of 20mA: 5Ω±5% Range of 200mA: 1Ω±10% Range of 2000mA: 0.1Ω~0.2Ω	Not including the resistance of the probe
Data recording frequency	2 records/second	
Data recording time	0.5s~9999h	
Safety parameters		
Resistance, capacitance, diode measurement protection	<400V	If connect the voltage beyond the range by error, it will cause some permanent damages to the tester.
Fuse	Dimension: 5*20mm,2A/250V Slow burn-out type fuse	Only for current measurement
Electrical isolation	>1.5KV	mA, COM, V/Ω are the interfaces for electrical measurement, which shall be isolated from all other interfaces.

3.14 System setting

The function of system setting can be used to set some operation parameters of the system, Which also includes USB storage function and system upgrade function.

Click the button "System setting" to select the function of system setting, and then enter the interface of system setting.

(as shown in the figure).



Setting the automatic shutdown time

Select the option of "Automatic shutdown", and then use the button of "+ / -" to adjust the options. The adjustment step is 5 minutes. The minimum time is 5 minutes, and the maximum is 60 minutes. When the time is 5 minutes, if continue to press the button of "-", it will be disabled. At this time, the function of automatic shutdown is disabled.

When it has lain idle till the set time, the tester will automatically shut down.

Setting the keyboard prompt tone

Click the option of "Keyboard tone", and then select/press the button to switch ON/OFF the tone.

Setting the screen language

The tester supports a variety of languages for display. Click/select the desired language on the screen, and then just save it.

Modifying the backlight brightness

For the display screen of the tester, its backlight brightness can be adjustable at 10 levels. In outdoor environment with strong light, a higher brightness is needed to improve the contrast of screen, while a lower brightness can reduce the power consumption of the tester.

Select the option of "Backlight brightness", and then use the button of "+ / -" to adjust the options; after that, the backlight brightness will change immediately.

Adjusting the system time / date

Click the button of "+ / -" corresponding to the date / time, and adjust them to a correct one respectively, then just click the button of "Save".

System upgrade

The tester supports the function of online upgrade.

First connect to a router that can access Internet by using RJ45 network cable or via WIFI, and then click the button of "IP settings" to enter the interface of network parameters (as shown in the figure).

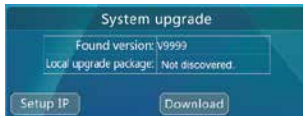

If DHCP services are provided in the network, you can select the key of "DHCP" to automatically acquire IP, DNS and gateway address. Otherwise, you need to select "Manual setting", and then enter IP, DNS, gateway and other contents. In addition, it also supports the online upgrade through WIFI connection.

After the setting is completed, click the button of "Check the new version". It will automatically connect to the software upgrade server on internet, and then searching for a new software version. When a new version is found, it will be displayed. Press the button of "Download" for downloading. The download process is automatic. After the download is completed, the integrity of file package will be checked automatically.

Depending on the network condition, the download process may take several seconds to dozens of minutes. Please try to use broadband connection for downloading, so as to save your valuable time.

After the download is successful, a prompt of "Starting the upgrade" will be displayed on the screen.

After the completion of the upgrade, the system will be restarted automatically. Enter the interface of "Upgrade", and then press the button of **SET** to start a formal upgrade according to the prompts on the screen.

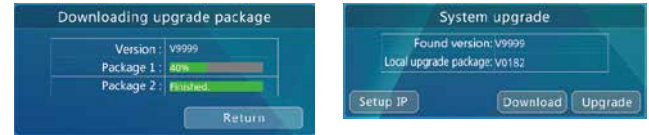

! Before upgrading, please confirm that the battery level is more than 30%. It is better for the tester to use an external power supply and be charged at the same time during the upgrading process, so as to avoid any damages to the software system caused by halfway power outage.

In the process of upgrading, do not open the back cover, do not take off the battery, do not press the button of "Reset"; otherwise, it may cause some damages to the system, which will not be able to start up.

USB storage



Due to data sharing, USB storage is disabled by default. When need to use the function of USB storage, enter the interface of system setting, and then select the function of USB storage to enter the interface of USB storage.

Use a USB cable to connect the tester and the host computer, whose operation method is consistent with that of other USB storage devices. When using the function of USB storage, please don't press the button of **MODE** or "Power" to shut down the tester. This operation will make the USB storage device be uninstalled from the host computer by force, which may cause some loss of storage data.

To disconnect USB from the host computer, please first safely eject the device, or uninstall the device from the host computer, and then disconnect the USB cable.

Viewing the serial number of the device

After entering the interface of system setting, the serial number of the device will be displayed at the last line.

3.15 Audio test

The function of audio test of the tester can be used to test the pickups (microphones) and other audio devices on the front end of video surveillance, so as to test whether the sound of the front end audio device is normal.

Use the matching 3.5MM connecting line to connect the audio signals. (Black clip: Ground wire; Red clip: Signal cable.) Please first connect the ground wire, and then connect the signal cable, so as not to input a larger noise.

3.16 Using POE to power the device

This tester supports POE power supply. After using an ordinary network cable to connect the tester's Network port 1 (blue) and the POE device, the tester can supply the power to the device immediately.

Please note that the POE devices connected must meet the standards of 802.3af or 802.3at, otherwise the tester will not supply the power to them. Therefore, it is safe to connect the non-POE devices via Network port 1 (blue).

When using POE power output, you can enter Step 1 of ONVIF test to view the actual power of POE output.



The maximum power of POE power output is 25.5W. When the power exceeds this limit, the tester will stop the output automatically.

It is forbidden to connect any non-standard POE power supply to Network port 1 (blue), otherwise it may damage the tester.

When using POE power output, due to the power consumption of external devices is large, it will greatly reduce the working time of built-in batteries.

3.17 Using 12V/2A output to power the camera

This tester supports 12V power output, whose maximum current is 2A. The actual current is determined by the External device.

After using a matching 12V output cable to connect 12V output interface and the camera, the tester can supply the power to the device immediately.

Attention: If Network port 1 (blue) is connected with a standard POE device, the tester will give priority to the POE power supply, while 12V power supply will be disabled.

When using 12V power output, you can enter Step 1 of ONVIF test to view the actual power of 12V output. If the power output is displayed as "POE", it indicates that the current state is POE, meanwhile 12V output is disabled.



Attention:

It is prohibited to connect any external power supply (e.g. charger, etc.) to the power output port of this device (DC12V/2A OUTPUT); otherwise, the tester and /or the external power supply will be damaged.

The maximum current of 12V power output is 2A. When the current exceeds this limit, the tester will stop the output automatically.

When using 12V power output, due to the power consumption of external devices is large, it will greatly reduce the working time of built-in batteries.

Specifications

Model	HD Combine Tester
IPC test	
IPC protocol	ONVIF, RTSP, RTP
Ethernet Test	10M/100M/1G Ethernet link detection; Ethernet loop detection; DHCP client and server; Ethernet traffic detection, data link quality detection.
IPC Test	Discovering the device, real-time video, camera configuration, PTZ test, discovering ONVIF device cross the network segment
IPC Image Test	H.264/H.265 decoding, support 4K@30FPS, local zoom preview (at 8 levels)
Interface	Dual-port RJ45 Ethernet 1Gbps, support Series/bridge connection
WI-FI test	
WIFI test	Support 2.4G and 5G frequency band, WIFI connection, WIFI list, WIFI information detection, delay detection, test of packet loss rate.
Spectrum test	Support 2.4G and 5G frequency band, spatial frequency band signal scanning and detection, and spatial noise (interference) signal detection.
Signal monitoring	Support 2.4G and 5G frequency band quick monitoring of signal change, refresh frequency: 1-10Hz.
Antenna type	External foldable dual antenna. Dual band Dipole omnidirectional antenna
POE test	
PD test	The tester receives the power. 802.3at; power supply voltage detection
PSE test	The tester supplies the power. 802.3at; 25.5Wmax, PD actual power detection
Analog video test	
Video format	NTSC/ PAL/ HD-CVI3.0 standard/ AHD3.0 standard/ HD-TVI3.0 standard
Video signal	1Vpp
Video input/ output	Video IN BNC input, Video OUT BNC output
Video digital zoom	Support digital zoom at 8 levels
Video signal generator	Sending PAL / NTSC video test signal, sending CVI, AHD and TVI video test signal (720P/1080P).
HDMI signal test	
HDMI Input	Can receive 720P 25/30/50/60Fps,1080P 25/30Fps input signals for display
HDMI Output	Can output various formats of test images(720P 25/30/50/60Fps,1080P 25/30Fps)
12V power output	
Power output	12V/2A output Interface: Round, external diameter 4mm; Internal needle: 1.6mm
Audio test	
Audio test	1 x Audio signal input

Coaxial PTZ control test	
Communication interface	Video IN BNC interface
Communication protocol	CVI protocol (dahua coax), AHD protocol (Pelco c) and TVI protocol (Hikvision)
485 PTZ control test	
Communication interface	RS485
Communication protocol	More than 30 protocols, including Pelco-D/P, Samsung, Panasonic, Lilin and Yaan
Baud rate	150, 300, 600, 1,200, 2,400, 4,800, 9,600 and 19,200bps
LED lighting (flashlight)	
Head LED	2 x 35lm LED, wide angle
TDR cable test	
Cable test	Testing the length of network cable (4 pairs). Resolution: 0.1 meter; Accuracy: 1 meter. The maximum length of the measured cable is 130-200 meters (depending on the wire rod).
Power supply	
Charger	12V/1.5A 5.5mm round-plug power supply
Battery	Equipped with two battery compartments One special lithium battery pack can be placed in each battery compartment, with a single capacity of 18.5Wh. The combined working time is about 10 hours (it also can work with a single battery).
Charging	12V/1.5A charging, Power: 18W, max. Charging time: 3~4 hours.
Power saving	Can set the automatic switching of overtime and display the icon of battery level in real-time.
System parameters	
Display screen	7.0" TFT 1920*RGB*1200 (resolution),16.7M(color), Backlight brightness adjustable
Operation method	Power button, Master control keyboard with 13 keys, Full lamination technology capacitive Multi-touch screen (input)
Operation settings	Chinese / English interface, user optional
Automatic standby	Disabled / 5-60 minutes
Keyboard tone	Enabled / Disabled
Working environment and specifications	
Working temperature	-10 C~+55 C
Working humidity	30%-90%
Outline dimension	236.5x133.4x45.4mm

Digital multimeter

(Please refer to the manual for electrical parameters and safety parameters)

Item	Measuring range	Range of readings	Minimum resolution	Accuracy
DC voltage (DCV)	2V, 20V, 200V, 600V	±19999	0.1mV	±0.1%+8*
AC voltage (ACV) (True RMS)	20V, 200V, 600V	±1999	1V	±1.2%+3
DC current	20mA, 200mA, 2000mA	±19999	1uA	±0.1%+8*
AC current (True RMS)	20mA, 200mA, 2000mA	±1999	1uA	±1.2%+3
Resistor	2KΩ, 20KΩ, 200KΩ 2MΩ, 20MΩ	0~19999	0.1Ω	±0.1%+8*
Capacitance	2nF, 20nF, 200nF, 2uF, 20uF, 200uF, 2mF, 20mF	0~1999	1pF	±4%+5
Diode forward voltage drop	2V	0~19999	0.1mV	±0.1%+20
Conductivity test	2KΩ	0~19999	0.1Ω	±0.1%+20

Technical parameters of laser power meter

Type of detector	InGaAs
Calibration wavelength	1625nm, 1550nm, 1480nm, 1310nm, 1300nm and 850nm
Power measurement range (dBm)	-70 ~ +10 dBm
Measurement accuracy	<±0.3dB (-10dBm @ 22°C) <±0.5dB (Full-scale range @ 22°C)
Display resolution	Linear display:0.1%, Logarithmic display: 0.01dBm
Connector	Interchangeable FC/PC