

1

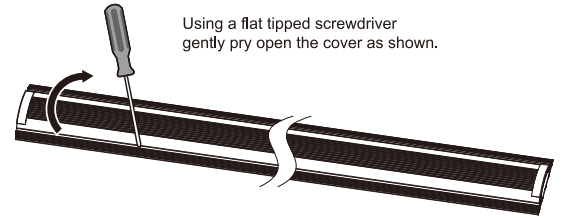

NOTE: Do not remove the end cap screws if you are not cutting the Ducting to a custom size. (Skip to Step 5 for managing cables)

2



Using a flat tipped screwdriver gently pry open the cover as shown.



3

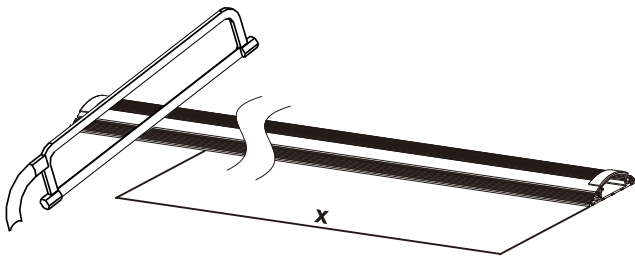

Using a hacksaw cut the ducting to desired length (Keep the cover Closed).

4

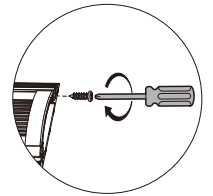

5

Insert the cables.
NOTE: Route cables within the grooved channels inside the ducting.

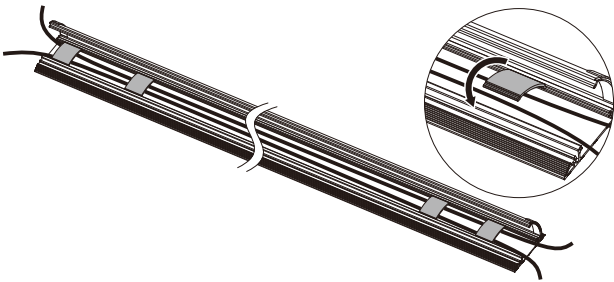
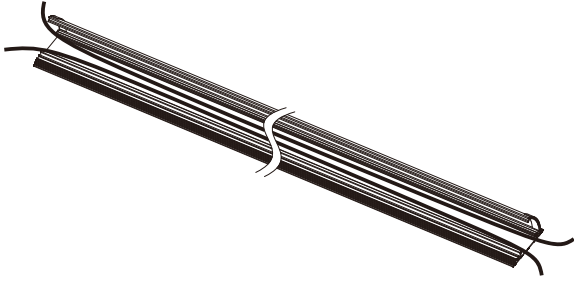

Attach the plastic cover to the base to secure cables in place.

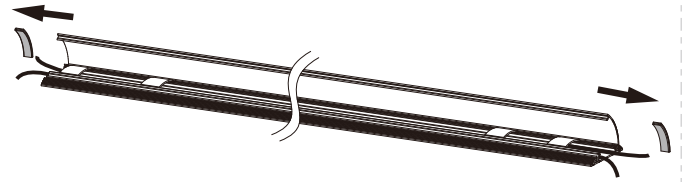

6

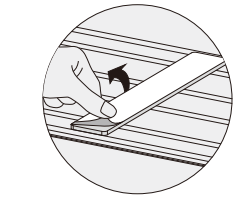
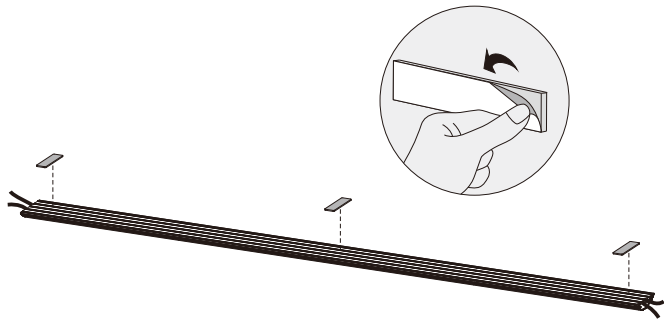

To prevent the ducting from moving, attach double-sided tape as required.
NOTE: Double-sided tape is recommended when using the ducting on hard floors.

7



Position your ducting in the desired location.