

## NDS-5704-F360LE Fixed dome 12MP 360° IP66 IR

### FLEXIDOME panoramic 5100i IR



- ▶ 360° panoramic overview in 12MP resolution without blind spots
- ▶ Optimized for all lighting conditions with integrated IR and High Dynamic Range
- ▶ Edge or client-side dewarping for easy integration and flexible viewing and recording
- ▶ Built-in Intelligent Video Analytics and Audio AI to trigger relevant alerts and quickly retrieve data
- ▶ Compact design protected against vandalism and all weather conditions

The NDS-5704-F360LE is a discreet and aesthetic panoramic camera for indoor and outdoor surveillance.

Its stereographic, panoramic lens provides full 360° coverage without blind spots, ideal for surveillance applications that require wide area coverage in a single, detailed view. The camera offers full situational awareness and simultaneous high-resolution zoomed-in images. The high-end system on chip (SoC) provides dewarping for easy integration and flexible viewing and recording.

Built-in Intelligent Video Analytics enriches full situational awareness and triggers relevant alerts. Audio AI gives meaning to the sounds it captures. The camera's integrated IR provides the flexibility to control IR intensity in multiple zones to prevent IR saturation. Additionally, with its wide range of inputs and outputs, such as Alarm and video output for HDMI-compatible devices, it can be used for any application.

The camera has an IK10 and IP66 design to protect itself against vandalism and all weather conditions.

#### Functions

##### 12MP sensor resolution

The camera offers a 12MP sensor to optimize for the amount of details required. This offers 30 fps to ensure real-time motion in your scenes. Together with its stereographic lens the image circle offers a 9MP effective resolution.

##### Panoramic vision and Intelligent Video Analytics

Combining Bosch Intelligent Video Analytics software with full panoramic vision, produces an extremely powerful surveillance tool, which enriches full situational awareness. With intelligent tracking, movement can be followed continuously throughout the full image circle. There is no need to hand off tracking from one camera to another, greatly simplifying movement analysis.

The system reliably detects, tracks, and analyzes objects, and alerts you when predefined alarms are triggered. A smart set of alarm rules makes complex tasks easy and reduces false alarms to a minimum. Specifically designed for the most demanding environments. It is extremely resistant to false triggers caused by challenging environments with snow, wind (moving trees), rain, hail, and water reflections. Calibration is quick and easy - just enter the mounting height of the camera. The internal gyro/accelerometer sensor provides the rest of the information to precisely calibrate the video analytics.

**Camera Trainer**

Based on examples of target objects and non-target objects, the Camera Trainer program uses machine learning to allow the user to define objects of interest and generate detectors for them. In contrast to the moving objects that the Intelligent Video Analytics application detects, the Camera Trainer program detects both moving and non-moving objects and classifies them immediately. Using Configuration Manager, you can configure the Camera Trainer program using both live video as well as recordings available through the respective camera. The resulting detectors can be downloaded and uploaded for distribution to other cameras.

A free of charge license is required to activate the Camera Trainer program.

**Audio AI**

The camera has an integrated microphone array with three digital microphones for audio analytics and Audio AI. It offers an alarm functionality for events such as glass breaking, gunshot detection, screaming, or other loud noises. The camera is not only able to classify sounds, but also to provide an approximate location of the sound. There is no need to record audio, as it is possible to examine sound characteristics only.

If required by local laws, the microphone can be permanently blocked via a secure license key. As Audio AI is under development, certain features might not be available at release or performance can be limited.

**Dewarping**

The lens captures a circular image. Our dewarping software transforms this circular image into several different distortion-free rectangular views. To facilitate system integration, you can choose edge dewarping inside the camera or client-side dewarping on an external platform.

The edge dewarping in the camera provides three separate video channels simultaneously:



- Full image circle (Video 1 channel)
- Dewarped view mode (Video 2 channel)
- E-PTZ (Video 3 channel)

Different view modes can be selected for the video 2 channel. Your selection depends on the resolution you require and how you wish to view the dewarped image.

**View modes**

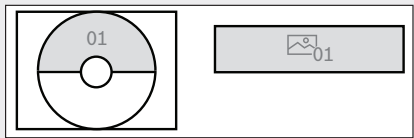
The following view modes can be select in the camera or on the client:

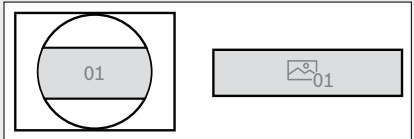
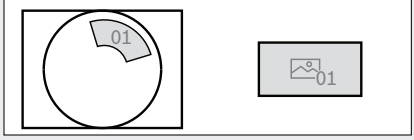
	Full image cut-out and displayed image
Panoramic view (ceiling mount)	

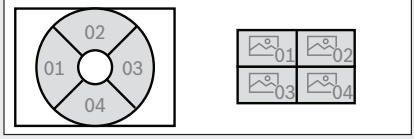
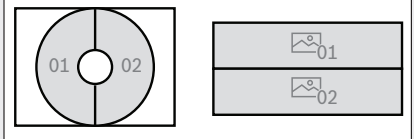
	Full image cut-out and displayed image
Panoramic view (for 180° wall mount)	
E-PTZ view	
Full panoramic view	
Quad view	
Double panoramic view	

**Video output for HDMI devices**

The camera has a video output with 1080p resolution for live streaming to a public view monitor ideal for retail usage or for local video display. Via its micro HDMI connector, the camera can display the full image circle on HDMI-compatible devices.

With a future firmware version, it will offer the flexibility to also display dewarped view modes.

**High Dynamic Range**

The camera has High Dynamic Range. This is based on a multiple-exposure process that captures more details in the highlights and in the shadows even in the same scene. The result is that you can easily distinguish objects and features, for example, faces with bright backlight.

The actual dynamic range of the camera is measured using Opto-Electronic Conversion Function (OECF) analysis according to IEC 62676 Part 5. This method is used to provide standardized measurements, which can be used to compare different cameras.

**DORI coverage**

DORI (Detect, Observe, Recognize, Identify) is a standard system (EN-62676-4) for defining the ability of a person viewing the video to distinguish persons

or objects within a covered area. The maximum distance at which a camera/lens combination can meet these criteria is shown below:

When mounted at 3 m (10 ft) height the camera has the following coverage radius for the four DORI levels for a person in the scene:

DORI	DORI definition	Coverage radius
Detect	25 px/m (8 px/ft)	45.5 m/ 149 ft
Observe	63 px/m (19 px/ft)	18 m/ 60 ft
Recognize	125 px/m (38 px/ft)	8.5 m/ 28 ft
Identify	250 px/m (76 px/ft)	3.8 m/ 13 ft

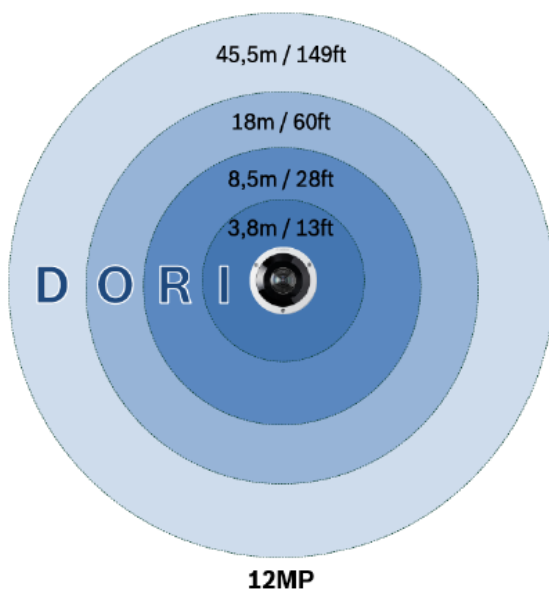

### E-PTZ and regions of interest

The remote E-PTZ (Electronic Pan, Tilt and Zoom) controls allow you to select specific areas of the full image circle. These Regions of Interest (ROI) can be easily defined, allowing the most interesting part of a scene to be monitored separately. The high resolution ensures that details are not lost even when using the electronic zoom.

The E-PTZ feature of a panoramic camera has some advantages over normal PTZ cameras. There is no camera movement so the camera does not draw attention to itself or appear intrusive. Situational awareness is still retained even when zooming in on a particular object of interest. The smooth E-PTZ function helps navigation, and presets are available for setting up a guard tour.

Intelligent tracking is also available to track people through the entire view of the camera.

### Record exactly what you want

The camera provides the full resolution circular image for recording even if you are viewing only a portion of the scene. This means that you can always perform retrospective dewarping and analysis on the complete area covered and then zoom in on the region or object of interest.

With edge-dewarping you can also choose to only record the relevant parts of the scene which helps reduce bitrates significantly.

### Scene modes

The camera has a very intuitive user interface that allows fast and easy configuration. Multiple preset configurable modes are provided with the best settings for a variety of applications. Different scene modes can be selected for different situations, such as sodium lighting or dark environments.

### Edge recording

Insert a memory card into the card slot to store up to 2 TB of local alarm recording. Pre-alarm recording in RAM reduces recording bandwidth on the network, and extends the effective life of the memory card. It has advanced edge recording providing a reliable storage solution possible due to the combination of these functions:

- Industrial SD card support allows for extreme lifetime
- Health monitoring of industrial SD cards provide early service indications.

### Data security

Special measures have been put in place to ensure the highest level of security for device access and data transport. The three-level password protection with security recommendations allows users to customize device access. Web browser access can be protected using HTTPS and firmware updates can also be protected with authenticated secure uploads. The cameras have built-in Secure Element (SE) hardware providing main Trusted Platform Module (TPM) functionality to ensure the highest levels of data security and privacy protection. Together with Public Key Infrastructure (PKI) support, superior protection from malicious attacks is guaranteed. It also supports RSA encryption key lengths of up to 4096 bits, ensuring data safety beyond 2030. The 802.1x network authentication with EAP/TLS, supports TLS 1.2 with updated cipher suites including AES 256 encryption. The advanced certificate handling offers:

- Bosch origin device certificate pre-installed
- Self-signed unique certificates automatically created when required
- Client and server certificates for authentication
- Client certificates for proof of authenticity
- Certificates with encrypted private keys

### Modular accessories

A full line of modular accessories is available that allows a consistent design across different cameras and a wide range of installation possibilities. Available options include wall or pipe mount, a surveillance cabinet with power and fiber optic options, and an in-ceiling mounting kit. There is also a conduit adapter available for installations on concrete walls or ceilings.

### H.265 high-efficiency video encoding

The camera is designed on the most efficient and powerful H.264 and H.265/HEVC encoding platform. The camera is capable of delivering high-quality and high-resolution video with very low network load. With a doubling of encoding efficiency, H.265 is the compression standard of choice for IP video surveillance systems.

### System integration and ONVIF conformance

The camera conforms to the ONVIF Profile S, ONVIF Profile G, ONVIF Profile M, and ONVIF Profile T specifications. For H.265 configuration, the camera supports Media Service 2, which is part of ONVIF Profile T. Compliance with these standards guarantees interoperability between network video products regardless of manufacturer. Third-party integrators can easily access the internal feature set of the camera for integration into large projects. Visit the Bosch Integration Partner Program (IPP) website ([ipp.boschsecurity.com](http://ipp.boschsecurity.com)) for more information.

### Cloud-based services

The camera supports time-based or alarm-based JPEG posting to four different accounts. These accounts can address FTP servers or cloud-based storage facilities (for example, Dropbox). Video clips or JPEG images can also be exported to these accounts. Alarms can be set up to trigger an e-mail or SMS notification so you are always aware of abnormal events.

### Bosch Remote Portal

With the secure cloud infrastructure, Bosch Remote Portal, you can manage your connected Bosch devices. From the Bosch Remote Portal you can:

- Complete initial configuration of your connected Bosch devices (online or offline).
- Update firmware for single or multiple devices.
- Manage certificates.
- Monitor the health of your connected Bosch devices.

### Two-way audio and built-in microphone

Two-way audio allows the operator to communicate with visitors or intruders via an external audio line input and output. Alternatively, there is an integrated microphone to capture crisp and clear audio. By using the integrated or external microphone, audio detection can be used to generate alarms to alert the

security operator quicker and act more proactively. If required by local laws, the microphone can be blocked via a secure license key.

### Resists rain, dust, and tampering with reliable operation across a wide temperature range

Suitable for indoor and outdoor usage.

The robust design of the camera is rated to IP66 and IK10 standards, safeguarding the camera against rain and dust while also offering protection against vandalism and tampering.

The camera can operate in a wide ambient temperature range between -40 °C up to +55 °C / -40 °F up to 131 °F.

### Regulatory information

Standards	Type
Emission	EN 55032 CFR 47 FCC part 15, Class A
Environmental	EN IEC 63000: 2018 EN 50130-5: 2011 RoHS EU, 2011/65/EU and 2015/863/EU WEEE EU, 2012/19/EU NEMA TS-2 chapter 2.1
Immunity	EN 50121-4 EN 50130-4
Marks	CE, FCC, UL, WEEE, RCM, VCCI, CMIM, UKCA, China RoHS
Safety	EN 62368-1 EN 60950-22 UL 60950-22 UL 62368-1, 2nd edition CSA C22.2 No. 62368-1-14, 2nd edition
Image performance	IEC 62676-5
ONVIF conformance	EN 50132-5-2, EN 62676-2
Impact protection	EN 62262 (IK10)
Ingress protection	EN 60529 (IP66) and UL50E (NEMA Type 4X)
IR lighting	IEC 62471

**Installation/configuration notes**

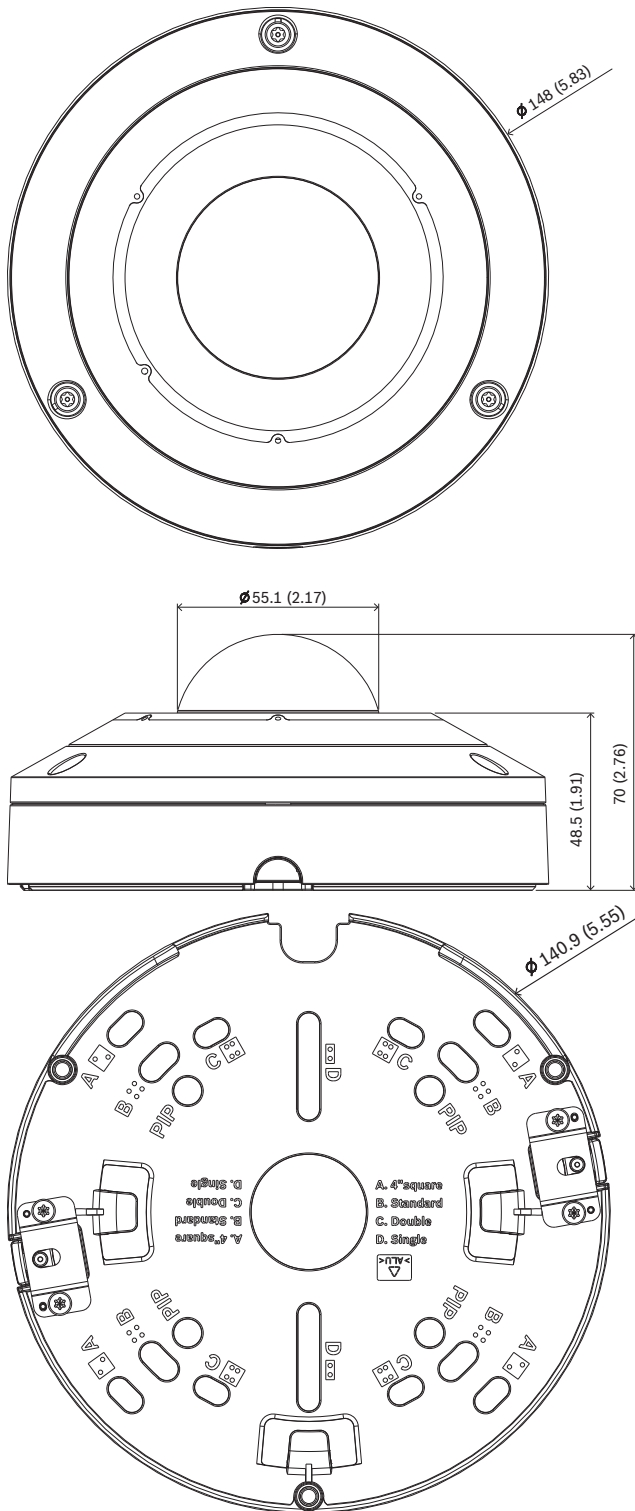

Dimensions in mm (inch)

**Parts included**

Quantity	Component
1	Mount plate

Quantity	Component
1	Camera base
1	Camera dome cover
1	TR20 Allen key for camera installation
1	8-pin Audio and I/O connector
1	2-pin power connector
1	RJ-45 punch-through aid
2	M20 rubber grommets (attached to the camera)
1	Quick installation guide
1	Safety information
3	Installer UX labels

**Technical specifications**

Power	
Input voltage	PoE IEEE 802.3af / 802.3at Type 1, Class 3 24 VAC $\pm 10\%$ 12 VDC $\pm 10\%$ PoE and auxiliary power can be connected simultaneously for redundant operation
Power consumption (DC)	13.4 W max.
Power consumption (AC)	13.3 W max.
Power consumption (PoE)	11.4 W max.
Sensor	
Total sensor pixels	12 MP
Type	1/2.3-inch CMOS
Used pixels	3008 x 3008 (9 MP)
Video performance - Sensitivity	
<b>Measured according to IEC 62676 Part 5 (1/25, F2.0)</b>	
Color	0.150 lx
Mono	0.048 lx

<b>Video performance - Sensitivity</b>	
<b>Measured according to IEC 62676 Part 5 (1/25, F2.0)</b>	
With IR	0 lx
<b>Video performance - Dynamic range</b>	
Wide Dynamic Range	120 dB WDR
Measured according to IEC 62676 Part 5	106 dB WDR
<b>Video streaming</b>	
Video compression	H.265; H.264; M-JPEG
Streaming	Multiple configurable streams in H.265, H.264 and M-JPEG, configurable frame rate and bandwidth. Multiple channels with edge dewarping (available with a future firmware version) Regions of Interest (ROI)
Overall IP Delay	Min. 120 ms, Max. 340 ms
GOP structure	IP, IBP, IBBP
Frame rate (12 MP)	1-30fps 1-25fps in HDR mode
Encoder regions	Eight independent areas for setting encoder quality to optimize bitrate.
<b>Video resolution (H x V)</b>	
Video 1 channel	Full image circle 3008 x 3008 (9 MP)
Video 2 channel (available with a future firmware version)	Various dewarped modes (Full panoramic, double panoramic, quad, corridor, E-PTZ)
Video 3 channel (available with a future firmware version)	E-PTZ
Multiple lower resolutions available and individually selectable per channel and stream	
<b>Video functions</b>	
Day/Night	Color, Monochrome, Auto (adjustable switchover points)
Adjustable picture settings	Contrast, Saturation level and control, Brightness, Sharpness
White Balance	2500 to 10000K, 3 automatic modes (Basic, Standard, Sodium vapor), Manual mode and Hold mode

<b>Video functions</b>	
Shutter	Automatic Electronic Shutter (AES) Default shutter (1/30 [1/25] to 1/500) selectable
Backlight compensation	Off / On
Noise reduction	Dynamic Noise Reduction
Privacy Masking	Eight independent areas, fully programmable
Scene modes	Multiple default modes with scheduler
Pre-positions	Six independent sectors (available with a future firmware version)
Display stamping	Individual names and stamps for all video channels
Other functions	Pixel counter, Video watermarking, Location
<b>Video content analysis</b>	
Analysis type	Intelligent Video Analytics, Camera Trainer
Alarm rules (combinable)	Any object, Object in field, Line crossing, Enter / leave field, Loitering, Follow route, Idle / removed object, Counting, Occupancy, Crowd density estimation, Condition change, Similarity search, Flow / counter flow
Object filters	Duration, Size, Aspect ratio, Speed, Direction, Color, Object classes (4)
Tracking modes	Standard (2D) tracking, 3D tracking, 3D people tracking, Ship tracking, Museum mode
Object classes	Person, car, bike, truck
Calibration / Geolocation	Automatic, based on gyro sensor and camera height
Audio AI	Gunshot detection, glass-break detection, loud noises detection (available with a future firmware version)
<b>Night vision</b>	
Distance	20 m (66 ft)
LED	360° LED high efficiency array, 850 nm
IR intensity	5 controllable zones
<b>Optical</b>	
Lens	1.26 mm fixed-focus lens F2.0
Lens mount	Board mounted

Optical	
Iris control	Fixed iris
Day/Night	Switchable IR-cut filter
Field of view	182° (H) x 182° (V)
Minimum object distance	0.1 m
Local storage	
Internal RAM	5 s pre-alarm recording
Memory card slot	Micro SDXC / SDHC / SD card
Industrial SD cards	Extreme lifetime and health monitoring support (if supported by the SD card) that provides early service indication.
Input/output	
Audio line in	0.707 Vrms max, 10 kOhm typical
Audio line out	0.707 Vrms at 16 Ohm typical
Alarm input	1 input
Alarm input activation	Short or DC 5V activation
Alarm output	1 output
Alarm output voltage	30 VDC, max. load 0.5 A
Video output for HDMI-compatible devices	Micro HDMI connector and 1080p resolution with dewarped viewing possibilities (dewarped viewing available with a future firmware version)
Microphone	Integrated array with 3 digital MEMS audio sensors
Ethernet	RJ-45
Fiber optics (sold separately)	The Fiber Optic Ethernet Media Converter kit (VG4-SFPSCKT) installed inside a Surveillance Cabinet (NDA-U-PA0, NDA-U-PA1 or NDA-U-PA2) provides the fiber optic interface to the mounted camera.
Audio streaming	
Standard	G.711, 8 kHz sampling rate L16, 16 kHz sampling rate AAC-LC, 96 kbps at 32/48 kHz sampling rate
Signal-to-Noise Ratio	>50 dB

Audio streaming	
Audio Streaming	Full-duplex / half duplex
Platform	
Common product platform	CPP14
Data security	
Secure Element ("TPM")	RSA 4096 bit, AES/CBC 256 bit
PKI	X.509 certificates
Encryption	Full end-to-end encryption with supported VMS Network: TLS1.0/1.1/1.2, AES128, AES256 Local storage: XTS-AES
Video authentication	checksum, MD5, SHA-1, SHA-256
Firmware protection	Signed firmware, secure boot
Network	
Protocols	IPv4, IPv6, UDP, TCP, HTTP, HTTPS, RTP/RTCP, IGMP V2/V3, ICMP, ICMPv6, RTSP, FTP, ARP, DHCP, APIPA (Auto-IP, link local address), NTP (SNTP), SNMP (V1, V3, MIB-II), 802.1x, DNS, DNSv6, DDNS (DynDNS.org, selfHOST.de, no-ip.com), SMTP, iSCSI, UPnP (SSDP), DiffServ (QoS), LLDP, SOAP, Dropbox™, CHAP, digest authentication
Ethernet	10/100/1000 Base-T, auto-sensing, half/full duplex
Connectivity	Auto-MDIX
Interoperability	ONVIF Profile S ONVIF Profile G ONVIF Profile M ONVIF Profile T
Mechanical	
Dimensions (Ø x H)	148 x 70 mm (5.83 x 2.76 in)
Lens adjustment (rotation)	355°
Weight	0.82 kg (1.81 lbs)
Color	White (RAL9003)
Gyrosensor	Yes
Dome bubble	Polycarbonate, clear with UV blocking anti-scratch coating

Mechanical	
Housing	Aluminum with dehumidifying membrane and waterproof connection area
Mounting	Mounting plate included for surface mount, 4-inch square junction box, single and double gang box
Conduit	Compatible with conduit back box for 3/4-inch NPT (M25) conduit side entry (sold separately)
Environmental	
Operating temperature	IR on: -40 °C to +50 °C (-40 °F to 122 °F) IR off: -40 °C to +55 °C (-40 °F to 131 °F)
Storage temperature	-40 °C to +70 °C (-40 °F to 158 °F)
Operating humidity	5% to 93% RH non-condensing 5% to 100% RH condensing
Storage humidity	Up to 98% RH
Impact protection	IK10
Ingress protection	IP66 and NEMA Type 4X
Sustainability	PVC free

### Ordering information

**NDS-5704-F360LE Fixed dome 12MP 360° IP66 IR**  
360° 12MP panoramic camera with HDR, IVA, microphone array for Audio AI, video output for HDMI-compatible devices, H.265, vandal and weather protection  
Order number **NDS-5704-F360LE | F.01U.385.631**

### Accessories

**NDA-5080-PIP Pendant interface plate, 148mm**  
Pendant interface plate for FLEXIDOME panoramic 5100i IR  
Order number **NDA-5080-PIP | F.01U.389.607**

**NDA-U-WMT Pendant wall mount**  
Universal wall mount for dome cameras, white  
Order number **NDA-U-WMT | F.01U.324.939**

**NDA-U-WMP Wall mount plate**  
Back plate for universal wall mount, corner mount and pole mount, white, IP66  
Order number **NDA-U-WMP | F.01U.324.950**

**NDA-U-PMT Pendant pipe mount, 12" (31cm)**  
Universal pipe mount for dome cameras, 31 cm, white  
Order number **NDA-U-PMT | F.01U.324.940**

**NDA-U-PMTE Pendant pipe extension, 20" (50cm)**  
Extension for universal pipe mount, 50 cm, white  
Order number **NDA-U-PMTE | F.01U.324.941**

**NDA-U-PMTS Pendant pipe mount, 4" (11 cm)**  
Universal pendant pipe mount for dome cameras, 11 cm (4"), white  
Order number **NDA-U-PMTS | F.01U.385.046**

**NDA-U-PSMB Pendant wall/ceiling mount SMB**  
Surface mount box (SMB) for wall mount or pipe mount.  
Order number **NDA-U-PSMB | F.01U.324.942**

**NDA-U-PMAS Pole mount adapter small**  
Pole mount adapter small  
Universal pole mount adapter, white; small.  
Order number **NDA-U-PMAS | F.01U.324.943**

**NDA-U-PMAL Pole mount adapter large**  
Universal pole mount adapter, white; large  
Order number **NDA-U-PMAL | F.01U.324.944**

**NDA-5080-PC Paintable cover, F360E, 4pcs**  
Paintable cover FLEXIDOME panoramic 5100i IR  
Order number **NDA-5080-PC | F.01U.394.004**

**NDA-5080-TM Tilt mount 20-deg, 148mm**  
Tilt mount (20°) for FLEXIDOME IP 4000i / 5000i (IR) and FLEXIDOME panoramic 5100i IR camera families  
Order number **NDA-5080-TM | F.01U.389.606**

**NDA-U-CBB Conduit back box, 148mm**  
Outdoor conduit back box, 148mm, IP66 rated  
Order number **NDA-U-CBB | F.01U.394.006**

**NDA-U-CMT Corner mount adapter**  
Universal corner mount, white  
Order number **NDA-U-CMT | F.01U.324.946**

**NDA-U-PMTG Pendant pipe mount, gang box**  
Universal pipe mount, compatible with gang box installation for fixed dome cameras only, white  
Order number **NDA-U-PMTG | F.01U.358.359**

**NDA-U-WMTG Pendant wall mount, gang box**  
Universal wall mount, compatible with gang box installation for fixed dome cameras only, white  
Order number **NDA-U-WMTG | F.01U.358.358**

**NPD-3001-WAP Portable installation tool**  
Bosch camera portable and wireless installation tool  
Order number **NPD-3001-WAP | F.01U.353.329**

**NPD-5001-POE Midspan, 15W, single port, AC in**  
Power-over-Ethernet midspan injector for use with PoE enabled cameras; 15.4 W, 1-port  
Weight: 200 g (0.44 lb)  
Order number **NPD-5001-POE | F.01U.305.288**

**NPD-5004-POE Midspan, 4 port x 15W, AC in**  
Power-over-Ethernet midspan injector for use with PoE enabled cameras; 15.4 W, 4-ports  
Weight: 620 g (1.4 lb)  
Order number **NPD-5004-POE | F.01U.305.289**

**VG4-SFPCKT Ethernet to SFP interface kit**  
Ethernet media converter video transmitter/data receiver fiber optic kit for AUTODOME cameras, for MIC-IP-PSU for MIC analog cameras and for the Surveillance cabinets (NDA-U-PA0, NDA-U-PA1 and NDA-U-PA2).  
Order number **VG4-SFPCKT | F.01U.142.529**

**SFP-2 Fiber module, multimode, 1310nm, 2LC**

SFP Fiber Optic Module, 2 km (1.2 miles), 2 LC connectors.

Multi-mode

1310 nm

Order number **SFP-2 | F.01U.136.537**

**SFP-3 Fiber module, single-mode, 1310nm, 2LC**

SFP Fiber Optic Module, 20 km (12.4 miles), 2 LC connectors.

Single-mode

1310 nm

Order number **SFP-3 | F.01U.136.538**

**SFP-25 Fiber module, 1310/1550nm, 1SC**

SFP Fiber Optic Module, 2 km (1.2 miles), 1 SC connector

Multi-mode

1310/1550 nm

Order number **SFP-25 | F.01U.136.541**

**SFP-26 Fiber module, 1550/1310nm, 1SC**

SFP Fiber Optic Module, 2 km (1.2 miles), 1 SC connector

Multi-mode

1550/1310 nm

Order number **SFP-26 | F.01U.136.542**

**MSD-064G IP SECURITY MICROSD CARD 64GB**

64 GB industrial microSD card with health status monitoring

Order number **MSD-064G | F.01U.394.680**

**MSD-128G IP SECURITY MICROSD CARD 128GB**

128 GB industrial microSD card with health status monitoring

Order number **MSD-128G | F.01U.394.681**

**MSD-256G IP SECURITY MICROSD CARD 256GB**

256 GB industrial microSD card with health status monitoring

Order number **MSD-256G | F.01U.394.682**

**Services****EWE-FDP51R-IW 12 mths wrty ext Flexidome Pan 5100i IR**

12 months warranty extension

Order number **EWE-FDP51R-IW | F.01U.397.323**

**Represented by:**

**Europe, Middle East, Africa:**  
Bosch Security Systems B.V.  
P.O. Box 80002  
5600 JB Eindhoven, The Netherlands  
Phone: + 31 40 2577 284  
[www.boschsecurity.com/xc/en/contact/](http://www.boschsecurity.com/xc/en/contact/)  
[www.boschsecurity.com](http://www.boschsecurity.com)

**Germany:**  
Bosch Sicherheitssysteme GmbH  
Robert-Bosch-Ring 5  
85630 Grasbrunn  
Tel.: +49 (0)89 6290 0  
Fax: +49 (0)89 6290 1020  
[de.securitysystems@bosch.com](mailto:de.securitysystems@bosch.com)  
[www.boschsecurity.com](http://www.boschsecurity.com)

**North America:**  
Bosch Security Systems, LLC  
130 Perinton Parkway  
Fairport, New York, 14450, USA  
Phone: +1 800 289 0096  
Fax: +1 585 223 9180  
[onlinehelp@us.bosch.com](mailto:onlinehelp@us.bosch.com)  
[www.boschsecurity.com](http://www.boschsecurity.com)

**Asia-Pacific:**  
Robert Bosch (SEA) Pte Ltd, Security Systems  
11 Bishan Street 21  
Singapore 573943  
Phone: +65 6571 2808  
Fax: +65 6571 2699  
[www.boschsecurity.com/xc/en/contact/](http://www.boschsecurity.com/xc/en/contact/)  
[www.boschsecurity.com](http://www.boschsecurity.com)